



ACCESSORIES
NEW SEASON



EVERY
EBIKE
HAS A
MISSION





06

RIDER

- 08 CYCLING CLOTHING
- 15 PROTECTIVE GEAR
- 16 CYCLING SHOES
- 17 CASUAL CLOTHING
- 18 GLOVES
- 20 SUNGLASSES
- 24 HELMETS
- 36 BACKPACKS



BICYCLE

- 42 LIGHTS
- 48 REFLECTIVE ACCESSORIES
- 45 PHONE HOLDERS
- 45 CYCLE COMPUTERS
- 52 BOTTLES
- 54 BOTTLE CAGES
- 56 BAGS
- 61 CHILD SEATS
- 62 BASKETS
- 63 CARRIERS
- 64 MUDGUARDS
- 66 KICKSTANDS
- 67 CHAINSTAY PROTECTORS
- 67 BICYCLE STORAGE SOLUTIONS
- 68 LOCKS
- 74 BELLS
- 76 MIRRORS
- 77 GRIPS
- 78 HANDLEBAR TAPES
- 80 SADDLES
- 84 PEDALS
- 86 HANDLEBARS, BAR ENDS STEMS
- 87 SEATPOSTS, SEAT PINS
- 88 PUMPS

SERVICE & CARE

- 94 TOOLS
- 98 CLEANERS & LUBRICANTS
- 102 BRAKE ACCESSORIES
- 106 WHEELS
- 107 RIMS, RIM TAPES
- 108 CHAINS
- 110 CABLES
- 111 TUBE REPAIR KITS
- 111 TUBES
- 112 TYRES
- 113 TUBELESS SYSTEMS



S E R I E S

RIDER



WITHOUT THE RIDER, THE BIKE IS GOING NOWHERE.

The feeling of comfort and safety is the key to the ultimate biking experience. Thanks to Kellys and KLS products dedicated by riders to riders, in addition to safety and comfort, you will receive high functionality, modern materials and a unique style. Get ready - the adventure awaits!



RIVAL 2
JERSEY SHORT SLEEVE

Rival 2 is premium short sleeve jersey made in a panel cut for maximal freedom of movement and comfort. Combination of high quality fabrics provides second skin feeling with high ventilation and moisture control. The jersey has a full-length zipper, and it has 3 pockets and one zipper pocket on the back side. Rival 2 jersey with elegant design added by smart reflective printing will keep you pedaling for hours.

COLORS_ blue, light
SIZES_ S, M, L, XL, XXL



TYRION 2
MTB JERSEY

Tyrion 2 lite is an ultra-light MTB jersey created in a comfortable fit, designed to be worn while mountain biking. Thanks to the quality, highly breathable and quick-drying fabric, this jersey is also perfect for longer rides in warm weather.

COLORS_ green, black
SIZES_ S, M, L, XL, XXL



STOKE
ENDURO / MTB SHORTS

Elegant and comfortable, Kellys Stoke MTB shorts are made of lightweight 4 - way stretch durable material ActivDry+ ensuring freedom of movement when biking. The internal width adjusting system on the waist and detachable inner shorts with antibacterial padding ensure a perfect fit and high comfort.

COLORS_ black
SIZES_ S, M, L, XL, XXL



AMOS
BASE LAYER

The first layer Kellys Amos is designed for warm summer rides. It ensures high breathability and effective moisture wicking. It works to keep you dry and regulate body temperature even during the long rides in hot weather. Amos is made of a fine microfiber and feels like a second skin on the body.

COLORS_ white
SIZES_ S, M, L, XL, XXL



RIVAL 2
BIBSHORT

Rival 2 multi-panel bibshorts are made of durable and breathable polyamide microfiber ensuring high comfort and optimal moisture and heat control. The bibshort straps are made of quality perforated material providing a second skin feeling. Anti-slip silicone application hold bibshorts in the right position. Antibacterial multi-level padding and smart reflective printing provide you with the best comfort and visibility.

COLORS_ black
SIZES_ S, M, L, XL, XXL



VULCANO
BIBSHORT

Vulcano unisex bib shorts are made of durable, functional Italian material. With anatomical construction and high quality fabric they ensure high comfort and optimal moisture and heat control. External pocket made of light yet durable mesh is practical companion during the ride. The elastic straps are made of mesh for lightness and breathability and provide a second-skin feeling. Anti-slip silicone application hold bibshorts in the right position. Antibacterial multi-level padding and smart reflective printing provide you with the best comfort and visibility.

COLORS_ black
SIZES_ XS, S, M, L, XL, XXL



MADDIE 3

WOMENS JERSEY

Maddie 3 cycling jersey is made of high-quality Italian functional fabric. It is light, breathable and comfortable. It has a tight-fit cut with slightly extended sleeves and three back pockets. The jersey has a quality YKK locking zipper for high comfort (it's easy to operate with one hand, does not move while riding). It's complemented by reflective elements for higher visibility and safety.

COLORS _ meadow, mist, fancy, flare

SIZES _ S, M, L, XL, XXL



MADDIE 3

TIGHTS SHORT

Maddie 3 cycling tights are made of durable functional Italian fabric. With anatomical construction and a raised waist for perfect fit and high comfort. Maddie 3 has antibacterial anatomically shaped padding and reflective prints for great visibility and safety.

COLORS _ black, petrol

SIZES _ S, M, L, XL, XXL



MADDIE 3

TIGHTS ¾

Maddie 3 cycling tights are made of durable functional Italian fabric. With anatomical construction and a raised waist for perfect fit and high comfort. Maddie 3 has antibacterial anatomically shaped padding and reflective prints for great visibility and safety.

COLORS _ black

SIZES _ S, M, L, XL, XXL



LEVITATE

ENDURO / MTB SHORTS

Sporty comfortable, Levitate MTB shorts are made of lightweight, durable material ActivDry+ ensuring optimal heat and sweat control and quick drying. The material is 4-way stretch ensuring perfect fit and freedom of movement. The internal width adjusting system, special ergonomic fit designed for woman and higher back profile on the waist ensure a high comfort on and off the trails.

COLORS _ black

SIZES _ S, M, L, XL, XXL



FLAME

THERMAL JACKET

Kellys Flame is lightweight handy jacket which is ideal for riding in colder, windy days. It's made in comfortable fit with elastic hems, higher collar and extended back part for maximum comfort. Front panel is made of waterproof and waterrepellent fabric, while back part is made of thermal brushed polyester ensuring optimal body temperature and right breathability at the same time. The jacket has three pockets and one zipper pocket on the back. The distinctive color of the jacket contributes to the excellent visibility and safety.

COLORS_ red
SIZES_ S, M, L, XL, XXL



RIVAL 2 STAY VISIBLE

THERMAL JACKET

Kellys Rival 2 Stay visible jacket will be your top choice to compete against cold weather, wind and the rain. Bright color of the membrane jacket fabric will make you visible on the road even from the distance. This jacket is made of the ITTAI® thermal, windproof and water repellent material with excellent breathability. Jacket has back opening which keeps you ventilated during the ride. Thanks to the 3 back pockets you will have room to bring all belongings you need with you and you'll stay visible even in the dark with the reflective printing.

COLORS_ lime
SIZES_ S, M, L, XL, XXL



RIVAL 2 BLEND IN

THERMAL JACKET

Kellys Rival 2 Blend in jacket will be your top choice to compete against cold weather, wind and the rain. The neutral color of the jacket will make you disappear in the mists of colder days. This jacket is made of the ITTAI® thermal, windproof and water repellent material with excellent breathability. Jacket has back opening which keeps you ventilated during the ride. Thanks to the 3 back pockets you will have room to bring all belongings you need with you and you'll stay visible even in the dark with the reflective printing.

COLORS_ petrol
SIZES_ S, M, L, XL, XXL



SWAY

CYCLING GILET

Kellys Sway is a lightweight windproof gilet with a front water-repellent panel. It is made of functional membrane material in combination with highly breathable mesh on the back side. This gilet is an excellent investment for both casual and active cyclists. It is compact, easy to fold and store in a back pocket of the jersey when no needed. It is suitable for windy days or during descents.

COLORS_ black
SIZES_ S, M, L, XL, XXL



LEVANTE

ULTRALIGHT WINDPROOF CYCLING JACKET

Levante is Ultralight windproof jacket which is made of functional, durable rip-stop material (against tearing) and complemented by breathable parts, that ensure ideal ventilation while riding. It is compact and can be easily packed in its back pocket. The jacket is universal to be worn during downhill rides or during windy weather as a membrane layer. Windpack has one back pocket and reflective prints for great visibility and safety.

COLORS_ lime
SIZES_ S, M, L, XL, XXL





THERMO ISOWIND

BIBTIGHTS

The front part is made of the Isowind® windproof fabrics and the rear part from SuperRoubaix® super-stretch thermo fabric for colder and windy days. With or without a breathable and anti-bacterial Hygienic® multilevel padding. Reflective printing for your safety.
SIZES_ S, M, L, XL, XXL



THERMO RBX

BIBTIGHTS

Made of the SuperRoubaix® super-stretch thermo fabric. These special multi-panel bibtights provides you with a comfortable fit. With or without a breathable and antibacterial Hygienic® multilevel padding. Reflective printing at the back panel for your safety.
SIZES_ S, M, L, XL, XXL



COOLMAX®

- wicks sweat away from body
- keeps you cool, dry and comfortable
- lightweight, soft and breathable
- DuPont performance tested and certified

SUPERROUBAIX®

- fast-recovery super-stretch fabric
- air permeable, strong, soft
- comfortable and easy care

ISOWIND®

- functional fabric with a comfort and easy-care properties:
- waterproof, windproof, water vapor permeable
 - 4 way stretch
 - keeps its shape



CAP WINDBLOCKER

It is designed to be worn under helmet. Made from a combination of different panels for optimal protection and moisture regulation. With Kellys reflective logo for your safety. One size fits all.



½ WINDBLOCKER CYCLING SHOE COVER

Shoecover WINDBLOCKER is made of functional membrane fabric – WINDBLOCKER. The shoecover protects sensitive parts of fingers against cold and moisture when riding in the cold weather (temperature range: 5 to 15 °C). Reflective prints were added for higher visibility and safety.

SIZES_ S/M 38-42, L/XL 43-47



ARM WARMERS
THERMO



KNEE WARMERS
THERMO



LEG WARMERS
THERMO

ARM/KNEE/LEG WARMERS THERMO

Made of quality elastic thermal fabric with great thermal performance to protect against cold. They are highly breathable and transports moisture to the outside. Anti-slip silicone application hold warmers on the right position and smart reflective prints for higher visibility and safety.

SIZES_ S, M, L, XL, XXL



SHOE COVERS WINDBLOCKER

Made of WINDBLOCKER windproof fabric to keep your feet warm. The covers have a full length zipper at the back for comfortable fit with a reflective velcro strap and reflective printing for your safety.

SIZES_ S/37-38, M/39-40, L/41-42, XL/43-44, XXL/45-46



BARE NEW BASIC UNIVERSAL SOCKS

Low profile socks made of cotton for great comfort. Anatomically shaped socks with reinforced middle part for perfect, stable and comfortable fit. Great to wear on and off the bike rides.

COLORS _black, white
SIZES _38 - 42, 43 - 47



SNUG NEW ROAD/XC/MTB SOCKS

Comfortable high functional socks are made in snug fit ensuring high comfort and right amount of support. They are anatomically shaped with cushioned foodbed parts for extra comfort in stressed areas. Thanks to upper mesh ventilation parts they offer high breathability. They have arch support and reinforced toe and heel parts. Snugger socks are made from high quality PROLEN® yarn with excellent moisture wicking properties, light weight and perfect thermal insulation. PROLEN® yarn is ecological choice and it's made in Slovakia.

COLORS _white, black
SIZES _39 - 42, 43 - 46



MERINO NEW ROAD/XC/MTB SOCKS

KLS Merino are low-weight comfortable socks made of blend of Merino wool and PROLEN® yarn. Socks are moisture resistant and naturally antibacterial, equally comfortable for 4-season cycling or casual wear. Thanks to its natural antibacterial characteristics they stay fresh for longer period of time. It's made of ecological choice of renewable wool and PROLEN® yarn in Slovakia.

COLOR _beige
SIZES _39 - 42, 43 - 46

TEAM NEW UNIVERSAL SOCKS

Comfortable, soft feel socks with Kellys Factory Team design, is #1 choice not only for pumped rides but also everyday wear. Blend of polyamide and cotton fibers ensure functionality with high comfort.

COLORS _white
SIZES _36 - 40, 40 - 45





VALEDOR
STRENGTHENING COMFORTABLE KNEE PADS

VALEDOR knee sleeves are an excellent option for every MTB rider who looks for minimal level of padding and high comfort. They are light, durable and flexible and thanks to breathable fabric and technical mesh they provide optimal air ventilation and high comfort while riding. They are sewn in multiple panels and are pre-shaped for perfect fit. The front side is covered with abrasion-resistant fabric for high durability. Silicon applications from inside on both top and bottom part ensure a secure fit even during long rides.

SIZES _ S, M, L



BEAT
MTB CYCLING SHOES

BEAT are comfortable and high quality MTB shoes. Thanks to the light yet stiff outsole, they provide great foot support and excellent power transfer when riding. The rubberized surface of the outsole increases traction when walking. Upper material is made of perforated synthetic leather providing optimal ventilation combined with durable TPU for longer shoe life span. The shoes have a reinforced toes in case of impact for event higher durability and comfort. Perforated upper material of the shoes provide optimal ventilation and is easy to maintain. Easy and secure high-quality Atop fastening on top of other advantages, makes the rides with the BEAT shoes very pleasant, and comfortable.

SIZES_ 38 - 46



EDGE
BICYCLE SHOES

Comfortable and durable XC bicycle shoes with fastening on 2 Velcro straps and one buckle for easy, quick and secure closure. Upper material is made of PU leather which is durable and thanks to numerous vents it provides excellent breathability. This material is also very easy to be taken care of.

COLORS_ lime, black

SIZES_ 38 - 46



IRIS NEW
T-SHIRT

Unisex t-shirt made of organic GOTS certified cotton. The mid-light fabric with soft touch makes it perfect and comfortable for everyday wear.

COLORS black

SIZES S,M,L,XL,XXL



LINE
CAP

65% polyester 35% cotton

Trucker cap

Emroidered logo

Original snapback

SIZE_ universal



PERKY
CAP

65% polyester 35% cotton

Trucker cap

Emroidered logo

Original snapback

SIZE_ universal



MODE
CAP

100% polyester

Trucker cap

Front foam

Original Snapback

SIZE_ universal



CORKY
CAP

80% acrylic 20% wool

Flat cork visor

Original snapback

SIZE_ universal



GRIT
CAP

100% polyester

5 panel cap

Embossed fake leather patch

Metalic buckle

SIZE_ universal





CUTOUT LONG NEW GLOVES

Sports watch compatible long finger gloves with unique cut-out which provides adequate space for the sports watch. Made of synthetic leather, micro fibre and neoprene for ultimate fit and performance. Special design of the index and middle finger tips for ultimate comfort and feel. Flat perforated palm area with silicone print for improved comfort, durability and control. Laser-cut vents on thumb provides additional cooling.

COLORS Black, Light grey, Terracota red
SIZES XS, S, M, L, XL, XXL



CUTOUT SHORT NEW GLOVES

Sports watch compatible short finger gloves with unique cut-out which provides adequate space for the sports watch. Made of synthetic leather, micro fibre and neoprene for ultimate fit and performance. Ergonomic padding for improved comfort, durability and control. Laser-cut vents provides additional cooling.

COLORS Black, Thunderstorm blue, Mint green
SIZES XS, S, M, L, XL, XXL



FACTOR NEW GLOVES

Lightweight well-ventilated gloves with foam padding. Made of lightweight and comfortable mesh material. Well padded palm area for better along with velcro closure provides superior comfort during ride. Palm made of anti-slip and perforated fabric.

COLORS Black, Slate blue, Green, Rose gold
SIZES XS, S, M, L, XL, XXL



YOGI LONG

YOUTH GLOVES

Junior long finger gloves with pre-curved fit
Wide opening Velcro wrist closure
Gel padding on palm area
Silicon print for better grip
Thumb area with absorbing towel
COLORS_ green, orange
SIZES_ S, M, L

YOGI SHORT

YOUTH GLOVES

Junior short finger gloves
Velcro wrist closure
Padded palm area
COLORS_ lime, purple, red
SIZES_ S, M, L



COLDBREAKER ^{NEW}

GLOVES

Ergonomically cut winter gloves provides optimal comfort in temperatures around freezing point. Gloves are made of breathable and windproof polyester material. Memory foam padding on the palm decrease the pressure on ulnar nerve. Reflective graphics design helps to keep rider visible during late afternoon winter rides. Thumb is made of absorbent microfiber.

COLORS_ black, lime
SIZES_ XS, S, M, L, XL, XXL

CAPE

GLOVES

Winter gloves made of breathable and windproof material
Longer cut for better protection against cold weather
Extra cover for fingers
Gel foam padding on the palm
Silicone fingertips for better grip
COLORS_ black, orange
SIZES_ XS, S, M, L, XL, XXL



D
I
C
E





Full-frame or half-frame option
(interchangeable bottom pieces)

Rubber injected
temple tips for
secure fit



Lightweight, durable and flexible two-piece
grilamid TR90 frame



100% UVA, UVB and UVC protection

Interchangeable wide-angle
lenses with anti-fog, anti-
scratch and water-repellent
coating



Adjustable
nose piece



DICE II
white



DICE II
gold polarized



DICE II
khaki



DICE II
black



DICE II
grey

DICE II SUNGLASSES

Lightweight frame made of durable swiss-made Grilamid TR90.
Full-frame or half-frame option (interchangeable bottom pieces)
Comfortable adjustable nose piece and rubber-injected temple tips.
Interchangeable polycarbonate wide-angle lenses
Coated with anti fog anti scratch and hydrophobic layer to provide top
visibility (100% UVA, UVB and UVC protection - up to 400 nm).
Meet EN standard EN 12312:2013
COLORS_ black, grey, khaki, white, gold polarized





RESPECT wine



RESPECT black



RESPECT blue

KLS RESPECT – our lifestyle best-seller valued for comfort, durability and unique look has reborn in 2021! All-new RESPECT glasses come with improved modern design while keeping the neat style of the 1st generation. Made of lightweight and durable swiss-made Grilamid TR90 provide durability and comfort so desired in sports and everyday use. Top-of-the-line optics with REVO filter protects you eyes while keeping great visibility.



RESPECT gold polarized

RESPECT SUNGLASSES

Frame made of durable swiss-made Grilamid TR90. Lightweight frame with rubber-injected temple tips. Performance: top-of-the-line lenses coated with anti fog anti scratch and hydrophobic layer to provide top visibility (100% UVA, UVB and UVC protection - up to 400 nm) Meet EN standard EN 12312:2013 **COLORS** _ black, blue, wine, gold polarized



H
C
L
T

FRAME

All types of sun glasses are made of Grilamid TR90, which is characterized by an extremely high flexural strength, flexibility and lightweight. Grilamid TR90 also excellently resists weather conditions and the effects of UV radiation. This material therefore ensures a long frame durability even during high performance.

ANTI-SCRATCH COATING

All lenses are equipped with special surface treatment which increases scratch resistance.

ANTI-FOG COATING

This lens treatment prevents fogging for certain time to avoid reduced visibility.

ANTI-WATER COATING

Surface treatment improves off-take of water droplets. It helps to keep the vision clear and without any distortion.

POLYCARBONATE LENSES

These lenses are characterized by lightweight and depending on the finish also by high durability and scratch-resistance.

PHOTOCHROMIC LENSES

Photochromic lenses are made of Polycarbonate. Depending on the intensity of UV radiation the lenses will be darker. If the UV radiation is removed (indoors or inside the car), the lenses will return to their clear state. These lenses are recommended to use outdoor only.

POLARIZED LENSES

The sun light itself is not polarized – it becomes polarized after the impact on a shiny surface (snow, water surface or road), when the reflected waves oscillate in two levels – horizontal and vertical. Sunglasses with polarized filter allow only the positive vertically reflected rays to reach your eye. Looking through such sunglasses is comfortable, clear and without glare. The horizontal group of sun rays is blocked out by the polarized filter. These lenses allow a colorful vision, better visual clarity and notable relief for the eyes.

FILTER CATEGORY	TINT	USE	LIGHT TRANSMITTANCE	
			From %	To %
0	Clear / Very Light	Cloudy, Evening	80	100
1	Light Tint	Cloudy Conditions	43	80
2	Medium Tint	Regular Conditions	18	43
3	Dark Tint	Sunny Conditions (sea, mountains)	8	18
4	Very Dark*	Very Sunny (glacier)	3	8

*Inappropriate for driving a vehicle and for using in road traffic



SPECTRE NEW
SUNGLASSES

Frameless design sunglasses provide 100% UVA, UVB and UVC protection up to 400nm. Lightweight frame is made of Swiss made Grilamid TR90 material for highest durability. Interchangeable polycarbonate lenses includes antiscratch and antifog lens coating. Patented lens changing technology provides quick and easy lens changing. Cuts on the lenses adjust airflow and decrease fogging. Comfortable and adjustable nose pads and injected rubber ends increase comfort. Meet EN standard: EN 12312

COLORS_ Black, Sand



**REVEAL
PHOTOCHROMIC NEW**
SUNGLASSES

Frameless design sunglasses provide 100% UVA, UVB and UVC protection up to 400nm. Lightweight frame is made of Swiss made Grilamid TR90 material for highest durability. Photochromic polycarbonate lenses includes antiscratch and antifog lens coating. Cuts on the lenses adjust airflow and decrease fogging. Comfortable nose pads and injected rubber ends increase comfort.

Meet EN standard: EN 12312

COLORS_ Black, Petrol

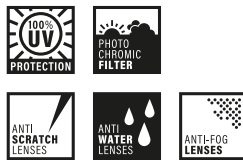

FORCE NEW
SUNGLASSES

New up to date version of Force sunglasses provides 100% UVA, UVB and UVC protection up to 400nm. Lightweight frame is made of Swiss made Grilamid TR90 material for highest durability. Interchangeable polycarbonate lenses includes antiscratch and antifog lens coating. Cuts on the lenses adjust airflow and decrease fogging. Comfortable and adjustable nose pads and injected rubber ends increase comfort. Sunglasses includes extra clear lenses. Meet EN standard: EN 12312

COLORS_ Black, Grey Photochromic, Cyan Blue





Goggle optimised with strap holder

Reinforced and extended back part

Twiceme technology



OUTRAGE PRO NEW HELMET

OUTRAGE PRO is a gravity helmet for riders expecting uncompromised performance and protection. Gravity riding requires top protection - this is why the safety was the key aspect when designing the all-new OUTRAGE. Triple inmold shell along with an extended back part and reinforced chassis provide top-of-the-line protection, so desired when riding hard. Coolmax padding and efficient ventilation system take care of a day-long comfort. OUTRAGE PRO is equipped with new AirGripSystem - adjustment system and Fidlock magnetic buckle for easy and fast fit. As many enduro riders use goggles, KLS new gravity helmet is equipped with goggle strap holder as well as adjustable two position visor with plenty of space underneath it for goggles. For additional safety, helmet is equipped with TWICEME chip.

COLORS _ garnet red, emerald green, sand, black
SIZES _ M/L (55-59 cm), L/XL (59-63 cm)

Thermoplastic bridge

3-position visor



OUTRAGE PRO
sand

TRIPLE-INMOLD
TECHNOLOGY

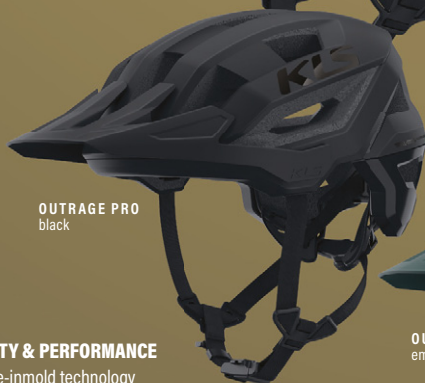

OUTRAGE PRO
black



OUTRAGE PRO
emerald green

SAFETY & PERFORMANCE

- _triple-inmold technology
- _reinforced chassis with bridge
- _AirGripSystem (AGS)
- _TWICEME chip
- _extended back part
- _reflective logos

COMFORT

- _Coolmax lining
- _enhanced ventilation

FIT

- _3D FIT adjustment system
- _Fidlock magnetic buckle



OUTRAGE PRO
garnet red



K
E
L
L
Y
S
B
I
C
Y
C
L
E
S



**BIGSEE
PRODUCTDESIGN
AWARD 2022
WINNER**

**SLOVAK DESIGN
AWARD 2021
SPORT
& LEISURE TIME
NOMINATION**

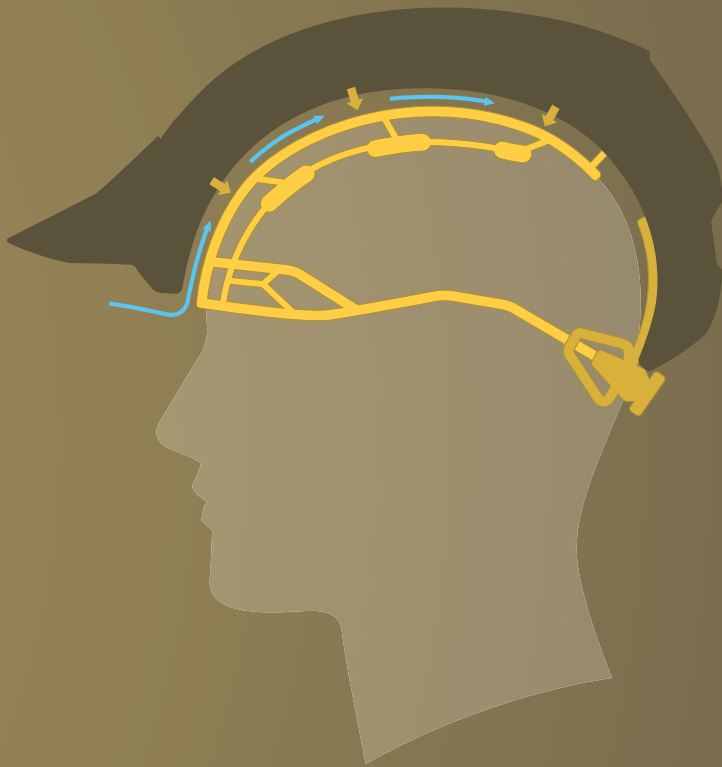

AGS AIR GRIP SYSTEM

Introducing the AirGripSystem (AGS) - the innovative new adjusting system. With AGS, your helmet fits better than ever before, ensuring both enhanced safety and supreme comfort.

By creating a small gap between your head and the EPS, AGS prevents uncomfortable pressure points and potential injury from head-to-EPS contact. Not only does this advanced system prioritize your safety, but it also promotes superior airflow for a cooler, more enjoyable ride.

Experience the difference with AGS and enjoy a helmet that molds perfectly to your head, providing unparalleled protection and comfort every time you hit the trail.



TWICEME: WE TURN BYSTANDERS INTO HELPERS

Twiceme Help The Helpers (HTH) Technology protects you before and after an incident. Twiceme allows the wearer to upload medical information onto the equipment, making it possible for any bystander or rescuer to help the person in need. By tapping the Twiceme symbol displayed on the equipment with a smartphone, you can alert the relevant emergency services, relay precise location and access the wearer's medical ID.

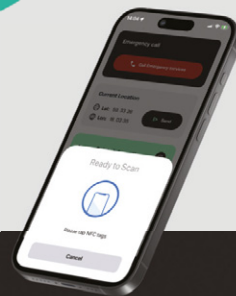

Alert

Guidance to national & local rescue services for faster treatment. Alert friends or loved ones that you are lost or injured.



Locate

Share & send your location. Follow friends for a set period of time - such as a day on the mountain.



Identify

Tap the Twiceme symbol on the equipment to access critical information of an injured person.

Get started by downloading the app.



Look for this symbol

Hold your smartphone directly over the Twiceme Symbol displayed on the product to access the wearer's Medical ID.





S H A R P



Thermoplastic bridge

Detachable 2-position visor

SHARP sky blue

Extended back part

SHARP green

TRIPLE-INMOLD TECHNOLOGY

SHARP grey pink

SHARP light grey

SHARP black

SHARP ADVENTURE HELMET

SHARP - modern adventure helmet for the most demanding mountain riders. Inspired by enduro helmets the all-new SHARP is equipped with extended back part for better head protection. Thanks to triple inmold technology combined with detachable visor, the helmet is lightweight while ensuring top-level safety and performance. Coolmax padding provide the ultimate comfort. SHARP is equipped with new 3D FIT adjustment system and Fidlock magnetic buckle for easy fit.

COLORS _ sky blue, pink, black, grey, green
SIZES _ M/L (54 - 58 cm), L/XL (58 - 61 cm)

SAFETY & PERFORMANCE

- _ triple-inmold technology
- _ reinforced chassis with bridge
- _ extended back part
- _ reflective logos

COMFORT

- _ Coolmax lining
- _ enhanced ventilation

FIT

- _ 3D FIT adjustment system
- _ Fidlock magnetic buckle





V A N T A G E





VANTAGE
black



TRIPLE-INMOLD
TECHNOLOGY



Aero-optimised shape

Carbon-fibre bridge

Anti-slip glasses
grippers



VANTAGE
white



VANTAGE
red



VANTAGE PERFORMANCE HELMET

VANTAGE is an all-new performance helmet. Thanks to triple inmold technology combined with carbon fibre bridge, the helmet is lightweight while providing top-level safety and comfort. Aero-optimised shape reduces air drag while keeping optimum air circulation, which combined with Collmax padding, ensure the thermal comfort. VANTAGE is equipped with new 3D FIT adjustment system and Fidlock magnetic buckle for fast and easy fit.

COLORS _ black, white, red
SIZES _ M/L (54 - 58 cm), L/XL (58 - 61 cm)

SAFETY & PERFORMANCE

- _ triple-inmold technology
- _ reinforced chassis with bridge
- _ extended back part
- _ reflective logos

COMFORT

- _ Collmax lining
- _ enhanced ventilation

FIT

- _ 3D FIT adjustment system
- _ Fidlock magnetic buckle

H
C
E
T



DARE II
yellow

Deeper shell and
bigger visor



DARE

Fidlock magnetic
buckle

DARE II

TRAIL BICYCLE HELMET

KLS DARE II is an upgraded version of our bestselling MTB helmet valued for versatility and comfort. The updated version got new features like double In-mold technology for even better durability and low weight. Thanks to a deeper shell and bigger visor the all-new KSL DARE II provides much better safety. The sunglasses holder, Fidlock magnetic buckle, and antibacterial padding make KLS DARE II a great companion to everyday rides, no matter if you're MTB rider or a commuter.



DARE II
dark grape



DARE II
steel blue



DARE II
sky blue



DARE II
black



DARE II
green

COLORS_ black, green, steel blue, sky blue, dark grape, yellow
SIZES_ S (52 - 55 cm), M (55 - 58 cm), L (58 - 61 cm)



D
A
R
E



RIDER / HELMETS

SERVICE & CARE

BICYCLE



CRUX NEW
HELMET

Introducing CRUX, the new standard in entry-level full-face helmets for enduro and downhill riding. Lightweight and breathable, CRUX offers solid protection at an accessible price point. Designed to keep you safe and comfortable on the trails, CRUX is the perfect choice for riders looking for reliable performance without breaking the bank. Get ready to conquer the mountains with CRUX by your side.

COLOR _black
SIZES _ M (56-58 cm), L (59-60 cm)



DYNAMIC II NEW
MTB-XC, ROAD, GRAVEL HELMET

Introducing the KLS DYNAMIC II: your upgraded go-to helmet for unmatched versatility and comfort. We've taken our bestselling helmet to the next level with enhanced features. Crafted with double In-mould technology, this helmet offers better durability and lower weight for maximum protection without compromising on comfort. Plus, the small removable visor ensures seamless adaptability - remove it, and you won't find any unsightly holes on the helmet.

We've included convenient features like a sunglasses holder, Fidlock magnetic buckle, and antibacterial padding with anti-insect internal netting. Versatile enough for road, gravel, and XC mountain riding, this helmet is engineered to keep you safe and comfortable no matter where your adventures take you.

COLORS _sand, black, rose gold, thunderstorm blue, lilac purple
SIZES _ S/M (52-55 cm), M/L (55-58 cm), L/XL (58-61 cm)





DAZE LUMIO NEW
MTB-XC HELMET

Made by In-mold technology. 14 vents for perfect head ventilation, easy and quick head size adjustment. Removable antibacterial inner padding for comfortable wearing and removable visor. Increased visibility by reflective stickers on the back of the helmet and USB charged LED light with 3 different modes.

COLORS _black, blue, green, pink, red, teal, grey
SIZES _S/M (52-55 cm), M/L (55-58 cm), L/XL (58-61 cm)

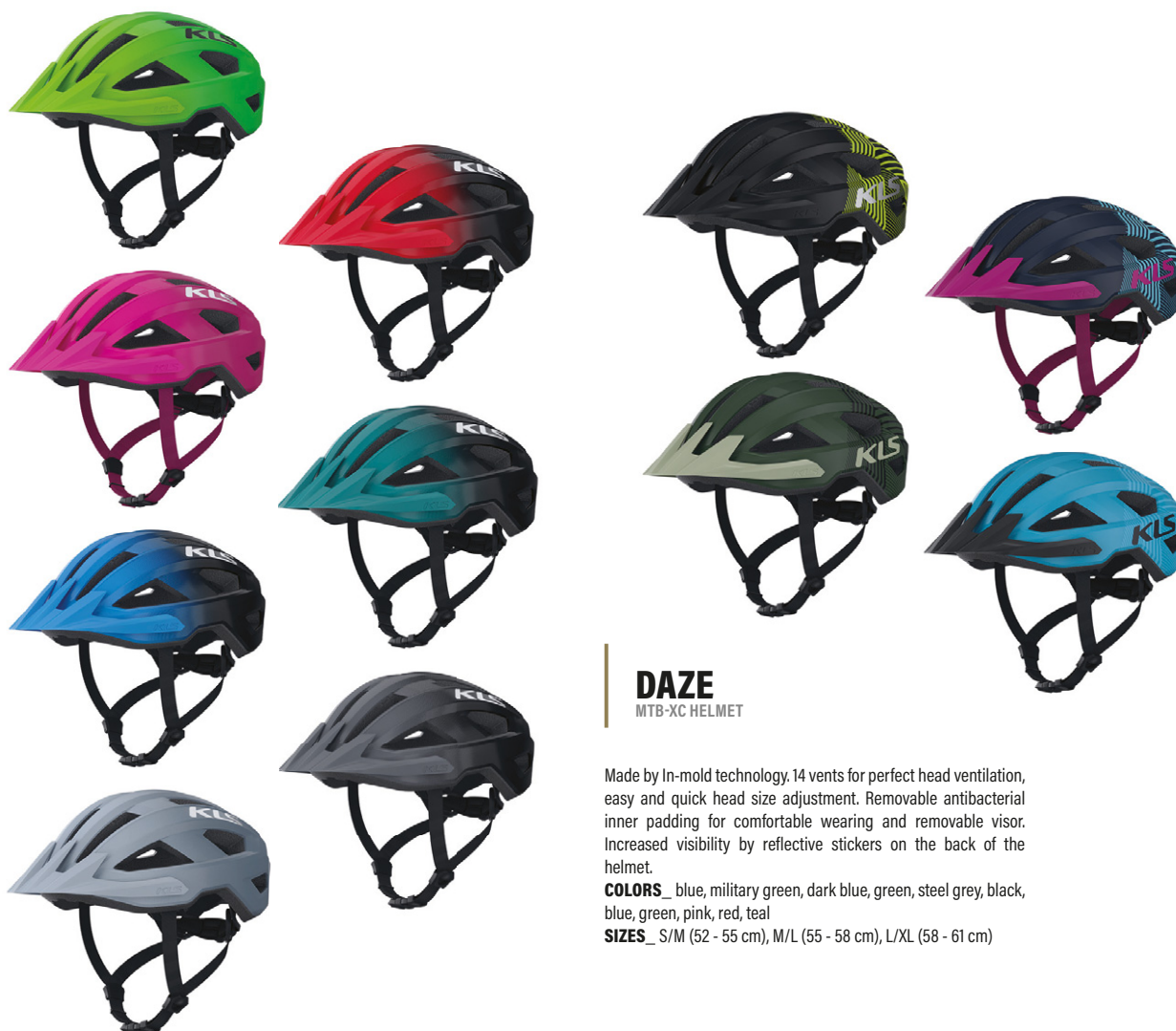

DAZE
MTB-XC HELMET

Made by In-mold technology. 14 vents for perfect head ventilation, easy and quick head size adjustment. Removable antibacterial inner padding for comfortable wearing and removable visor. Increased visibility by reflective stickers on the back of the helmet.

COLORS _blue, military green, dark blue, green, steel grey, black, blue, green, pink, red, teal
SIZES _S/M (52 - 55 cm), M/L (55 - 58 cm), L/XL (58 - 61 cm)



JUMPER BMX/DIRT HELMET

BMX / Dirt model with an EPS Inner shell designed to absorb the force of an impact, high of ABS outer shell strength provides protection, 12 air vents for cooling STL 3.0 (Simply Twist Lock 3.0) new vertically adjustable system for snug and secure fit, inner padding for comfort.

COLORS_ black, white, teal

SIZES_ S/M (54 - 57 cm), M/L (58 - 61 cm)



JUMPER MINI KIDS HELMET

Kids BMX model with an EPS Inner shell designed to absorb the force of an impact, high of ABS outer shell strength provides protection, 12 air vents for cooling STL 3.0 (Simply Twist Lock 3.0) new vertically adjustable system for snug and secure fit, inner padding for comfort.

COLORS_ lime, blue, yellow, red, blue-pink
SIZES_ XS/S (51 - 54 cm)

SPROUT KIDS HELMET

Kids fullface helmet for all adventurous kids. Air vents designed for great airflow. Removable visor and removable chin part. In-mold construction. Vertically adjustable system for snug and secure fit, inner antibacterial padding for comfort. Reflective stickers on the back of the helmet for increased safety of our little riders.

COLORS_ anthracite, racing lime
SIZES_ XS (47 - 52 cm), S (51 - 55 cm)



ACEY
KIDS HELMET

Helmet designed to increase children protection. Durable Inmold technology. Cooling is secured by 10 vents. Helmet has antibacterial padding and small integrated visor. Visibility is increased by reflective stickers on the back of the helmet. Adjusting system with big wheel for easy manipulation for kids and their parents also.

COLORS_ flash black, flash blue, rose pink, rose white, wasper lime, wasper red
SIZES_ XS (45 - 49 cm), S (49 - 53 cm)



ZIGZAG
KIDS HELMET

Helmet designed to increase children protection. Cooling is secured by 8 vents. Helmet has antibacterial padding and small integrated visor. Visibility is increased by reflective stickers on the back of the helmet. Adjusting system with big wheel for easy manipulation for kids and their parents also.

COLORS_ blue, lime, pink, purple, red, turquoise
SIZES_ XS (45 - 49 cm), S (49 - 53 cm)



A D E P T 1 0



ADEPT 10 CYCLING BACKPACK

KLS ADEPT 10 is compact and lightweight backpack with optimal size for everyday rides. It is equipped with comfortable and well-ventilated back panel along with perforated shoulder straps for high breathability. In KLS ADEPT 10 your things will be always organized thanks to inner pockets and separate section for water bladder. It includes helmet carrying mesh stowed in zipped pocket at the bottom of the backpack and sunglasses compartment.

VOLUME 10 L

COLORS black, terrazzo





ADEPT 5

CYCLING BACKPACK

Handy and ultralight XC backpack is suitable for riders focusing on comfort yet light weight. The backpack has super slim design. Comfortable back panel and perforated shoulder straps ensure high breathability and effective moisture wicking. Backpack can accommodate water bladder (up to 2 L) and its volume of 5 L makes it perfect choice for shorter rides or races. Waist belt in KLS Adept 5 is detachable.

VOLUME 5 L



LANE 16
BACKPACK

Technical bicycle backpack KLS LANE 16 is ideal for day bike trips. Plenty of pockets will help to organize all your goods which need during bike rides. EVA padded back panel and soft perforated shoulder straps keep KLS LANE 16 secure on your back.

- Made of Nylon combination 420D ripstop PU coated and Polyester 600D
- Helmet carrier for Full face and MTB helmet (straps are hideable)
- Separate section for water bladder (carry up to 3 L water bladder)
- Sunglasses/goggles padded compartment
- Inside sections for small goods such as tube, tire levers, pump, tools etc.
- Flexible hip belt straps
- Waterproof cover
- VOLUME_** 16 L
- COLORS_** mélange, wine



LANE 10
BACKPACK

Technical bicycle backpack KLS LANE 10 is ideal for day bike trips. Plenty of pockets will help to organize all your goods which need during bike rides. EVA padded back panel and soft perforated shoulder straps keep KLS LANE 10 secure on your back.

- Made of Nylon combination 420D ripstop PU coated and Polyester 600D
- Helmet carrier for Full face and MTB helmet (straps are hideable)
- Separate section for water bladder (carry up to 3 L water bladder)
- Sunglasses/goggles padded compartment
- Inside sections for small goods such as tube, tire levers, pump, tools etc.
- Flexible hip belt straps
- Waterproof cover
- VOLUME_** 10 L
- COLORS_** black





TANK 20

WATER BLADDER

Made of PEVA
 Wide opening Slide lock system for easy and comfort filling and cleaning
 Detachable 100 cm PVC tube with valve water lock system
 Neoprene sleeve on PVC tube included
VOLUME_ 2 L



TANK 30

WATER BLADDER

Made of PEVA
 Wide opening Slide lock system for easy and comfort filling and cleaning
 Detachable 100 cm PVC tube with valve water lock system
 Neoprene sleeve on PVC tube included
VOLUME_ 3 L



DAKOTA

WAIST BAG

Made of Polyester 600D / 210 Nylon
 Airflow contact system
 Side bottle holders
 Main pocket with inside organizing pockets
 Softened front pocket with organizing pockets
 Hip-belt pockets
VOLUME_ 5L
DIMENSIONS_ 24 x19 x12 cm



DAKOTA TRAIL

WAISTBAG

Minimalistic design and lightweight construction makes KLS DAKOTA TRAIL best choice for riders who prefer going light to carry backpack but still have their essentials on hand. Waist bag is equipped with one zipped compartment and two sides pockets. One is made of neoprene and the other one is mesh made and its suitable for energy bar or gel. Perforated back panel is comfortable and adhesive which keeps KLS DAKOTA TRAIL secure on your waist during your trail rides. The materials used for the waistbag KLS DAKOTA TRAIL are made from 100% recycled polyester fiber. Handy waist bag for daily bike rides
 Minimalistic and lightweight construction
 Made of recycled Polyester 600D ripstop PU coated
 One mesh pocket for small goods such as energy bar, one neoprene pocket for phone and one large zipped pocket
 Perforated back panel
VOLUME_ 1 L
COLORS_ black



DAKOTA MTB

WAISTBAG

KLS DAKOTA MTB is great option for half day rides. It will carry all the emergency goods to repair you bike. Waist bag is equipped with two zipped compartments and two side mesh pockets. Soft padded back panel is comfortable and adhesive which keeps KLS DAKOTA MTB secure on your waist during rides. Made of combination of Polyester 600D and Nylon 420D ripstop PU coated.
 One mesh pocket for small goods such as energy bar on one side, one zipped pocket on the other one and two zipped pocket in the middle of the bag
 Soft padded back panel
VOLUME_ 2 L
COLORS_ black



S E R I E S

BICYCLE



MAKE YOUR BIKE UNIQUE TO FIT YOUR RIDING STYLE.

Every rider is different, every bike needs to be different to fulfil individual mission. Kellys and KLS bike equipment and parts allow you to customise your bike and keep it running like brand-new. Ride your own way!



VARIANT NEW
HEAD LIGHT

Rechargeable aluminium alloy front light with maximum power 2300 lm
 Allows to connect and operate tail light KLS Visc
 Light source 2 strong LEDs
 LED lights can be turned on/separately
 Functions: Steady: High beam 2300 (1 hr), Medium beam 1000LM (2 hrs), Low beam 550LM (4 hrs),
 Flashing: High beam, Low beam, Breathing flash,
 Water resistant: IPX4
 Charging time: 3 hours
 Low battery indicator
 Universal bracket with rubber band
 Type-C rechargeable cable
DIMENSIONS 100 x 41 x 32 mm
WEIGHT 180 g



LUXIO NEW
HEAD LIGHT

Rechargeable aluminium alloy front light with maximum power 1000 lm
 Allows to connect and operate tail light KLS Visc
 Light source 1 strong LED
 Functions: Steady: High beam 1000 LM (2 hrs), Medium beam 500LM (4 hrs), Low beam 250LM (8 hrs),
 Flashing: High beam, Low beam, Breathing flash,
 Water resistant: IPX4
 Charging time: 3 hours
 Low battery indicator
 Universal bracket with rubber band
 Type-C rechargeable cable
DIMENSIONS 104 x 23 x 36 mm
WEIGHT 150 g



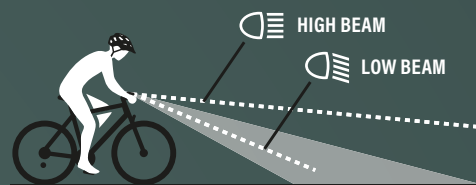

LUNA 1200 NEW

FRONT LIGHT

Aluminium alloy front light with maximum power 1200 LM

Two LEDs - upper and lower

Upper diode has long light function, lower spreads light to sides

Functions: 100% Brightness - 50% Brightness - Flashing - Breath flashing - Off Low beam
100% - Low beam 50% - Low beam flash - Low beam Breath flash - High beam & low
beam 100% - High beam & low beam 50% - High beam & low beam flash - High beam &
low beam Breath flash.

USB type C

Charging time: 5 - 6 hours

DIMENSIONS _113 x 30 x 36 mm

WEIGHT _150 g



AMBIO NEW

FRONT LIGHT

Rechargeable front light with maximum power 600 LM

Light source: one LED light

Function: 25% Brightness \ 50% Brightness \

100% Brightness \ Flashing

Waterproof design: IPX4

USB type C

Charging time _3 hrs

DIMENSIONS _70 x 42 x 25 mm

WEIGHT _67 g





STONE NEW FRONT LIGHT

Rechargeable front light with maximum power 550 LM
Light source: one LED Light
Functions: High beam - 100% brightness, Mid beam - 50% brightness Low beam - 25% brightness Flashing, Breath flashing, Long flashing
Charging time: 5 hours
Battery indicator
USB type C
DIMENSIONS _104 x 30 x 39 mm
WEIGHT _108 g



NOXY NEW FRONT LIGHT

Rechargeable compact tail light with maximum power 35 LM
COB high brightness LED with 25 chips (35 lumen)
4 lighting modes:
Eco Beam(30%)(9hr), Normal beam(30%)(4.5hr)
Medium beam(50%)(2.5hr), High beam(100%)(1.5hr)
4 flashing modes:
Slow flash normal beam, Slow flash medium beam,
Slow flash high beam, Quick Flash medium beam
Water resistant: IPX4
Charging time: 3 hours
Low battery indicator
Universal bracket with rubber band
Type-C rechargeable cable
DIMENSIONS _62 x 28 x 17 mm
WEIGHT _46g



VISIC NEW TAILLIGHT

Rechargeable tail light with maximum power 50 LM
Allows to connect and operate with front lights KLS Variant and KLS Luxio
COB high brightness with 16 chips (50 lm)
Lighting modes: Steady 100%, strobo, flashing and long flashing
Water resistant: IPX4
Charging time: 4 hours
Low battery indicator
Universal two position bracket with rubber band
USB type C
DIMENSIONS _80 x 21 x 24 mm
WEIGHT _ 44 g



LUMIO 400

BICYCLE HEADLIGHT

Aluminium alloy front light with maximum power 400 LM
 One strong LED
 High beam - 2.5 h, (400 LM)
 Mid beam - 3.5 h, (250 LM)
 Low beam - 5.5 h, (150 LM)
 Fast flashing - 3 h, (400 LM)
 Slow flashing - 3.5 h, (400 LM)
 USB type C
 Charging time: 2 hours
DIMENSIONS _ 70 x 45 x 30 mm
WEIGHT _ 90 g



LUMIO R

BICYCLE TAILLIGHT

LED type: COB LED
 8 lighting modes
 High beam - 0,75 h
 Mid beam - 2,5 h
 Pulse - 3 h
 Flashing - 6,5 h
 Rolling flashing - 7,5 h
 Side flashing - 1 h
 Disco flashing - 1,5 h
 Eco flashing - 8 h
 Adjustable bracket
 USB type C
 Charging time: 1 hour
DIMENSIONS _ 36 x 36 x 22 mm
WEIGHT _ 35 g



LUMIO SET

HEADLIGHT / TAILLIGHT



TWINRAY

SET

Light set with maximum power 100 LM
 One LED
 High beam - 3 h, (100 LM)
 Low beam - 6 h, (50 LM)
 Slow flashing - 6 h, (100 LM)
 Flashing - 6.5 h, (100 LM)
 Eco flashing - 23 h, (30 LM)
 USB type Micro
 Charging time: 2 hours
DIMENSIONS _ 53 x 53 x 32 mm
WEIGHT _ 40 g (each light)



TWINS

SET

Source of light: 2x LED
 Functions: 100%, Flashing 1, Flashing 2
 Battery lifetime: 70 hrs (100%), 140 hrs (Flashing)
 Battery type: 2x CR 2032 (included)
 Universal tool-free bracket fits all common stems, handlebars and seatposts.
 IPX 4 (Water resistant)
COLORS _ air force blue, anthracite black, lime green, mint white, red, steel grey

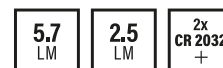



SEEKER

BICYCLE HEADLIGHT

Front light with maximum power 80 LM
One LED
4 lightning modes 100%, 50%, 25%, flashing
Handlebar bracket and helmet mount
USB type Micro
Charging time: 3 hours
DIMENSIONS _ 26 x 26 x 15 mm
WEIGHT _ 53 g



REVOLT USB

RECHARGABLE HEADLIGHT

Source of light: 1x LED
Functions: 100%, 50%
Battery lifetime: 3 hrs (100%), 6 hrs (50%)
Battery indicator: Red = 45 min (100%), Flashing Red = 10 min (100%)
Charging time: 4 hrs
Battery type: 18650 Li-ion 3,7 V 1300 mAh
USB cable included
360° adjustable, tool-free bracket fits all common handlebars
IPX 4 (Water resistant)
Double-click for turning ON, long-press for turning OFF



NOBLE SET USB

HEADLIGHT / TAILLIGHT

FRONT LIGHT _ REVOLT USB

REAR LIGHT _
Source of light: 1x UltraBright LED
Functions: 100%
Battery lifetime: 3 hrs
Battery indicator
Charging time: 2 hrs
Battery type: Li-pol 240mAh
USB cable included
IPX 4 (Water resistant)
Horizontally adjustable tool-free bracket
fits all common seatposts





RIPPY 2
BICYCLE TAILLIGHT

COB LED (Chip-on-board LED)
SideSafety System - light casing spreads the light to the sides for rider's better protection. Adjustable bracket and 90-degree rotation of the light on the bracket. Tool-free mounting bracket. Suitable for types seat posts. Water resistant.



URBANRIDE
BICYCLE TAILLIGHT

Battery supplied rear rack light
Mounting with screws
2 lighting modes 100% and flashing
DIMENSIONS 118 x 35 x 35 mm
WEIGHT 74 g



REVOLT
HEADLIGHT

Source of light: 1x LED
Functions: 100%, 25%, Flashing
Battery lifetime: 7 hrs (100%), 13 hrs (25%) 30 hrs (Flashing)
Battery type: 2x AA (included)
360° adjustable, tool-free bracket fits all common handlebars
IPX 4 (Water resistant)
Double-click for turning ON, long-press for turning OFF

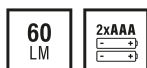

STRIKE SET
HEADLIGHT / TAILLIGHT

FRONT LIGHT_ REVOLT

REAR LIGHT_
Source of light: 3x LED
Functions: 100%, 50%, Flashing
Battery lifetime: 140 hrs (100%), 168 hrs (50%) 280 hrs (Flashing)
Battery type: 2x AAA (included)
Adjustable tool-free bracket fits all common seatposts
IPX 4 (Water resistant)

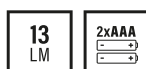



SHADOW

REFLECTIVE ARMBAND

Made of high gloss 3M Scotchlite reflective film
Back side made of 100% polyester velvet fabric
Tested and certificated by TÜV
Rheinland, Germany
Conforms to CE EN 13356
SIZES_ 3 x 30 cm, 3 x 40 cm



SPARKY

LED ARMBAND

Made of high gloss 3M Scotchlite reflective film
Back side made of 100% polyester velvet fabric
Tested and certificated by TÜV
Rheinland, Germany
Conforms to CE EN 13356



RADIATE

TROUSERS CLIP

Made of ABS plastic material
3M Scotchlite reflective material



TWILIGHT

REFLECTIVE BAND

Made of 100% Polyester
Tested and certificated by TÜV Rheinland, Germany
Conforms to CE EN 13356
SIZES_ 4 x 40 cm, 4 x 50 cm



TWINKLE PRO

LED SAFETY REFLECTOR WITH MAGNETIC CLIP

Made of high gloss 3M Scotchlite reflective film
Tested and certificated by TÜV
Rheinland, Germany
Conforms to CE EN 13356



TWINKLE SET

LED SAFETY REFLECTOR WITH VELCRO CLIP

Made of high gloss 3M Scotchlite reflective film
Tested and certificated by TÜV
Rheinland, Germany
Conforms to CE EN 13356



STARLIGHT

KIDS SAFETY VEST

Made of 100% Polyester
Size adjustment by velcro straps
Tested and certificated by TÜV Rheinland, Germany
Conforms to CE EN 1150
SIZES_ XXS - L



MOONLIGHT

REFLECTIVE STRAP VEST

Universal size / uni-sex
Fully adjustable
Tested and certificated by TÜV Rheinland, Germany
Conforms to CE EN 13356



RAY

REFLECTIVE CLIPS FOR SPOKES

Reflective plastic clips with easy „snap-on“ system makes you visible and more safe during the city night rides.



SPARKY PRO

LED ARMBAND

Made of high gloss 3M Scotchlite reflective film
Tested and certificated by TÜV
Rheinland, Germany
Conforms to CE EN 13356



NAVIGATOR

UNIVERSAL SMARTPHONE/ GPS HOLDER

This holder is softly padded to protect phone surface. Bracket could be 360 degrees rotated. Navigator has toolless installation and its extendable arms can hold devices with the size up to 95 mm*185 mm.



CLICK

UNIVERSAL LIGHTWEIGHT STEM MOUNT

CLICK - stem mount is secure, low profile and lightweight. It's easy to mount by only adding it to your stem. The mount comes with the longer screw for right and secure installation and the universal 3M™ adhesive patch which attaches directly on to your smartphone. Thanks to KLS Click your phone is securely placed in the center of your vision and allows you to quickly access your sports app, messages or navigator.

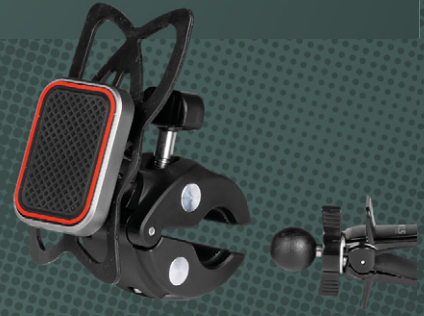

LINK

UNIVERSAL SMARTPHONE HOLDER

Universal powerful bike magnetic mount 360° rotated. Quality rubber finish on the top of the mount together with rubber bands to secure the phone guarantee to keep your smartphone in place regardless of road vibrations or impacts. This magnetic mount in sleek and elegant design is easy to use and it comes with an extra mount for the car use in the packaging.



HUGGER ^{NEW}

UNIVERSAL SMARTPHONE HOLDER

Detachable elastic silicone mobile holder is simple yet effective solution to hold your phone secure and on place while riding. Its tough and stretchy silicone bands can be stretched to fit most of the phone sizes. It has toolless installation and soft surface. The phone can be easily detached from the base with a hidden lever on the bottom side.



CONTROL

UNIVERSAL LIGHTWEIGHT
ALUMINIUM SMARTPHONE HOLDER

Easily adjustable to various width of the smartphones from 55 to 100 mm. Thanks to the two adapters which are included in the package you can mount the holder to handlebars with a diameter of 31.8 mm, 25.4 mm and 22.2 mm. It has easy installation and the package include 4 anti slip stickers for extra secure grip.



SWIPE

WATERPROOF SMARTPHONE HOLDER

360° rotating holder for your smartphone which comes in two sizes - medium and large. The water resistant housing protects your smartphone against the rain but still offers touch screen functionality. Softly padded back side offers additional protection of your smartphone. KLS SWIPE could be 360° rotated.



CONTEST

WIRED CYCLE COMPUTER

USB rechargeable cycle computer with 8 main functions and large current speed indication display. Quick mounting system for handlebar or stem and user-friendly control. Cycle computer has quick Autostart system.

8 FUNCTIONS

- Current speed
- Trip distance
- Total distance
- 12 / 24-hour clock
- Average speed
- Maximum speed
- Trip riding time
- Autostart system

CONTEST WL

WIRELESS CYCLE COMPUTER

USB rechargeable cycle computer with 8 main functions and large current speed indication display. Quick mounting system for handlebar or stem and user-friendly control. Cycle computer has quick Autostart system.

8 FUNCTIONS

- Current speed
- Trip distance
- Total distance
- 12 / 24-hour clock
- Average speed
- Maximum speed
- Trip riding time
- Autostart system



DIRECT

WIRED CYCLE COMPUTER

Advanced wired cycle computer with "low battery indicator", selectable display mode and automatically turn ON / OFF. Computer is waterproof. Easy mounting system.

7 FUNCTIONS

- current speed
- trip distance
- total distance
- 12 / 24 hour clock
- average speed
- maximum speed
- riding time

BATTERY _ computer - 3V CR2032

COLORS _ white, blue, green, red



DIRECT WL

WIRELESS CYCLE COMPUTER

Advanced wireless cycle computer with "low battery indicator", selectable display mode and automatically turn ON / OFF. Computer is waterproof. Easy mounting system.

7 FUNCTIONS

- current speed
- trip distance
- total distance
- 12 / 24 hour clock
- average speed
- maximum speed
- riding time

BATTERY _ computer - 3V CR2032, Sensor - 3V CR2032

COLORS _ white, blue, green, red



DIGIT

WIRELESS CYCLE COMPUTER

10 FUNCTIONS

- speedometer
- tripmeter (DST)
- odometer (ODO)
- auto trip timer (TM)
- maximum speed (MXS)
- digital clock
- average speed (AVS)
- scan of functions DST, MXS, AVS, TM
- speed comparator (+ / -)
- AUTO-START STOP system

Double space LCD display offers easy read-out, click release system, single-piece sensor including mounting bracket for handlebar.

BATTERY _ computer- 3V CR2032

COLORS _ black





SAVANA

CYCLING WATER BOTTLE 0,55L

SAVANA is lightweight, soft and resistant bottle made with BPA FREE plastics. PRO PUSH valve with membrane against unwanted leakage. Wide bottleneck for easy cleaning. Ideal for water, isotonic or other sport drinks without CO2. Suitable for dishwasher cleaning up to 65 °C.

WEIGHT _ 66 g

COLORS _ transparent black, transparent white



KOLIBRI

CYCLING WATER BOTTLE 0,55L

KOLIBRI is the lightest bicycle bottle with a volume of 550 ml on the market with only 53 g. Made with BPA FREE technology. Ideal for water, isotonic drinks or other sports drinks without CO2 up to 50 °C. Suitable for washing in the dishwasher.

WEIGHT _ 53 g

COLORS _ neon yellow, pink, transparent black, transparent blue, transparent white



EREBUS

CYCLING THERMO BOTTLE 0,5 / 0,65L

EREBUS is thermo bottle with removable plastic insert and insulating foil. Thermo version has 500 ml, version, while without isolation offers 650 ml. Bottle has rubber dust cap for mouthpiece protection. Made by BPA FREE technology. Suitable for water, isotonic drinks or other sport drinks without CO2 and temperature up to 50 °C. Suitable for dishwasher with temperature up to 50 °C (without insulating foil).

WEIGHT _ 159 g

COLORS _ black, brown



ANTARCTICA

WATER BOTTLE 0,65L

Original KLS design. Double wall with airspace and special aluminum foil. Bottle ANTARCTICA is a soft, lightweight, easy-to-use insulated bottle that keeps beverages cool or warm. Ultra-wide cap with rubber mouthpiece. Ultra-cap is easy to open, effortless to use, and leak-proof when closed. Made with BPA FREE technology for clean, pure refreshment. Suitable for water isotonic drinks, and other sport drinks without CO2 up to 60 °C. Made from BPA-free plastic.

WEIGHT _ 160 g

COLORS _ charcoal black, white



TULAROSA

WATER BOTTLE 0,75L

Original KLS design. Ultra-wide cap with rubber mouthpiece. Ultra-cap is easy to open, effortless to use, and leak-proof when closed. Made with BPA FREE technology for clean, pure refreshment. Suitable for water isotonic drinks, and other sport drinks without CO2 up to 40 °C. Made from BPA-free plastic.

WEIGHT _ 95 g

COLORS _ blue, green, grey, orange, pink, red



NAMIB

WATER BOTTLE 0,75L

Original KLS design. Ultra-wide cap with rubber mouthpiece. Ultra-cap is easy to open, effortless to use, and leak-proof when closed. Made with BPA FREE technology for clean, pure refreshment. Suitable for water isotonic drinks, and other sport drinks without CO2 up to 60 °C. Made from BPA-free plastic

WEIGHT _ 82 g

COLORS _ anthracite, transparent white, transparent blue, transparent red, transparent green



TRACE

WATER BOTTLE 0,55L / 0,75L

Original KLS design. Soft bottle with rubber mouthpiece, easy to open, effortless to use and leakproof when closed. Made with BPA FREE technology for clean, pure refreshment. Suitable for water isotonic drinks, and other sport drinks without CO2 up to 40 °C. Made from BPA-free plastic.

WEIGHT_ 0,5 L - 71 g / 0,75 L - 79 g

COLORS_ trail semi-transparent white, forest semi-transparent white



GOBI NEW

WATER BOTTLE 0,55L / 0,75L

Original KLS design. Soft bottle with rubber mouthpiece, easy to open, effortless to use and leak-proof when closed. Made with BPA FREE technology for clean, pure refreshment. Suitable for water isotonic drinks, and other sport drinks without CO2 up to 40 °C. Made from BPA-free plastic. Suitable for dishwasher.

WEIGHT_ 0,55L - 81g / 0,75L - 95g

COLORS_back trail theme



ATACAMA

WATER BOTTLE 0,65L

Original KLS design. Made with BPA FREE technology for clean, pure refreshment. Rubber mouthpiece with dust cover. Mouth piece is easy to open, effortless to use, and leak-proof when closed. Suitable for water isotonic drinks, and other sport drinks without CO2 up to 40 °C. Made from BPA-free plastic

WEIGHT_ 80 g

COLORS_ black, orange, green, pink, purple, tiffany blue



KALAHARI

WATER BOTTLE 1L

Original Kellys design, Wide bottleneck for easy cleaning and filling, Soft lockable mouthpiece made of soft plastic BergaFlex™, Made of high-quality polyethylene, Suitable for water, isotonic drinks and other sport drinks without CO2 up to 40 °C.

WEIGHT_ 117 g

COLORS_ anthracite, white



SPORT

WATER BOTTLE 0,7L

Ergonomic shape and original design, wide bottle-neck for easy cleaning and filling, soft lockable mouthpiece from soft plastic BergaFlex™, made of high quality and proper hygienic, materials polypropylene Borealis / Mosten.

WEIGHT_ 75 g

COLORS_ anthracite, lime, orange, red, silver, turquoise, white



RANGIPO

JUNIOR WATER BOTTLE 0,35L

Original KLS design that fits our children bikes. Made with BPA FREE technology for clean, pure refreshment. Childproof undetachable rubber mouthpiece to avoid suffocation. Mouth piece is easy to open, effortless to use, and leakproof when closed. Suitable for water isotonic drinks, and other sport drinks without CO2 up to 40 °C Made from BPA-free plastic. With 66 mm outer diameter fits to our bottle cage KLS RATIO JUNIOR.

WEIGHT _ 60 g

COLORS _ blue, pink



YOUNGSTER

JUNIOR WATER BOTTLE 0,35L

Original KLS design. Kids bottle made with BPA FREE technology with additive that makes the bottle decompose in shorter time. Biodegradable within 3 months to 5 years (depending on surrounding).

Rubber lid is easy to open and leak proof when closed. Bottle is dishwasher safe and easy to clean.

With 66 mm outer diameter fits to out bottle cage KLS RATIO JUNIOR.

WEIGHT _ 53 g

DESIGN _ flash, girl, cactus, mountain, zigzag



KOLIBRI JUNIOR ^{NEW}

JUNIOR WATER BOTTLE 0,55L

KOLIBRI is the lightest bicycle bottle with a volume of 550 ml on the market with only 53 g. Made with BPA FREE technology. Ideal for water, isotonic drinks or other sports drinks without CO2 up to 50 °C. Suitable for washing in the dishwasher.

WEIGHT _ 53 g

COLORS _ transparent kids



SLOT

BOTTLE CAGE MOUNT

Ø22 mm - 31.8 mm Universal plastic bottle cage mount adjustable for handlebars and seat post

Rubber pads for a better grip and scratch protection



CURE

BOTTLE CAGE

One piece nylon material
Including 2 stainless steel bolts
WEIGHT_ 29 g
COLORS_ black, blue, red, tiffany, white



SQUAD

BOTTLE CAGE

Material plate aluminum alloy 6061-T5
press-molding
Including 2 stainless steel bolts
WEIGHT_ 47 g
COLORS_ blue, green, pink, steel blue



PACIFIC

BOTTLE CAGE

Bottle cage made of resistant material
Nylon 66
2 stainless steel bolts included
WEIGHT_ 32 g
COLORS_ black, lime, pink



PATRIOT

BOTTLE CAGE

One piece polycarbonate material
Including 2 stainless steel bolts
WEIGHT_ 33 g
COLORS_ blue, pink, silver, teal



CALIBER

BOTTLE CAGE

Material aluminum alloy 6063 and
nylon Including 2 stainless steel bolts
WEIGHT_ 40 g
COLORS_ black, grey, lime



RATIO

BOTTLE CAGE

Material aluminum alloy 6463-T5
Including 2 stainless steel bolts
WEIGHT_ 59 g
COLORS_ black, grey, silver



RATIO JUNIOR

JUNIOR BOTTLE CAGE

Material aluminum alloy 6463-T5
Including 2 stainless steel bolts
WEIGHT_ 59 g
COLORS_ silver, black



DART

BOTTLE CAGE

Super lightweight aluminum bottle
cage. Including 2 stainless steel bolts
WEIGHT_ 18 g
COLORS_ silver



SPACE 10

REAR PANNIER BAG WITH LIGHTNING FABRIC

Made of Tarpaulin / 210D Nylon
USB rechargeable lightning fabric on the back of the bag.

Two side pockets
Inside pocket
Rubber band on the top of the bag
3M reflective piping
Safety light attachment
Six-point Velcro strap fastening
Detachable shoulder strap

VOLUME 10 L
DIMENSIONS 35 x 18 x 16 cm



TANAYA

REAR MTB EXPEDITION BAG

Made of Tarpaulin / Nylon 210D
Water resistant materials keeps your goods dry
Adjustable Velcro strap attachment and saddle rack (included) fits all seat posts and minimize swinging
Reinforced construction keeps better shape
Side pockets with quick access
Rubber straps can carry extra load

VOLUME 7 L
DIMENSIONS 57 x 17 x 20 cm



MAYA

TRIANGLE MTB EXPEDITION BAG

Made of Tarpaulin / 210D nylon
Adjustable Velcro strap fastening
Reinforced construction to keep better shape
Tool compartment

VOLUME 2,8 L
DIMENSIONS 38 x 12 x 6 cm



AURA

MTB HANDLEBAR EXPEDITION BAG

Made of 600D polyester / Nylon 1200D
Waterproof insert easy to take out
Attachments for other possible accessories
Velcro strap attachment fits all types of handlebars

VOLUME 9 L
DIMENSIONS 66 x 37 x 10 cm



ADVENTURE 40

REAR PANNIER BAG

Made of 600D polyester / Poly honeycomb / Nylon 210D
Two main compartments with two side pockets
Two rear zipped pockets
3M reflective piping
Fastening on rear carrier by straps and hooks
Waterproof raincover in lime colour with taped seams included in bottom pocket.

VOLUME 40 L
DIMENSIONS 32 x 20 x 40 cm (one side)



ADVENTURE 20

REAR PANNIER BAG

Made of 600D polyester / Poly honeycomb / Nylon 210D
Two main compartments with two smaller side pockets
Rubber band on the top of the bag
3M reflective piping
Fastening on rear carrier by straps and hooks

VOLUME 20 L
DIMENSIONS 33 x 10 x 28 cm (one side)



SPACE 10

REAR PANNIER BAG

Made of 600D polyester / 420D Nylon / 210D Nylon

Two side pockets

Inside pocket

Rubber band on the top of the bag

3M reflective piping

Safety light attachment

Six-point Velcro strap fastening

Detachable shoulder strap

VOLUME_ 10 L

DIMENSIONS_ 35 x 18 x 16 cm



SPACE 15

REAR PANNIER BAG

Made of 600D polyester / Poly honeycomb / Nylon 210D

Extendable 2 side pockets

Inside mesh pocket

Rubber band on the top of the bag

3M reflective piping

Safety light attachment

Velcro strap fastening

Detachable shoulder strap

VOLUME_ 15 L

DIMENSIONS_ 32,5 x 28 x 19 cm





ROLLER

CYCLING HANDLEBAR BAG

KLS ROLLER is a compact handlebar roll bag made to keep your essentials at hand. It's suitable for urban, touring and road bikes. Thanks to durable Polyester 600D and special reinforcement, KLS ROLLER keeps the shape and lasts for years. Thanks to 3-point mounting system, the roll bag stays on place no matter the load.
COLORS_flower, terrazzo



WEDGE

FRAME BAG

Made of recycled 600D Polyester / 210D Nylon
3M reflective piping
Velcro strap fastening
VOLUME_ 1,3 L
DIMENSIONS_ 22 x 19 x 5 cm
COLORS_ flower, terrazzo



LEAD

HANDLEBAR BAG

Made of 600D polyester / Poly honeycomb / PVC leather / Nylon 210D
Top transparent pocket for map or smartphone
2 mesh pockets and one front pocket
3M reflective piping
Shoulder strap included
Safety light attachment
Quick release system fits oversized handlebars
VOLUME_ 4 L
DIMENSIONS_ 25,5 x 14,5 x 12 cm

SPACE CITY

REAR PANNIER BAG

Made of recycled 600D polyester / Nylon 210D
Two side pockets
Inside mesh pocket
Adjustable inside sections
3M reflective piping
Safety light attachment
Velcro strap fastening
Carrying strap
VOLUME_ 10 L
DIMENSIONS_ 31 x 16 x 20 cm
COLORS_ flower, terrazzo



TRIANGLE

FRAME BAG

Made of recycled 600D polyester
3M reflective piping
Inner compartment with small mesh pocket
Velcro strap fastening
VOLUME_ small size 1 L, large size 2,5 L
DIMENSIONS_
Triangle large: 43 x 34 x 27 cm
Triangle small: 28 x 23 x 17 cm

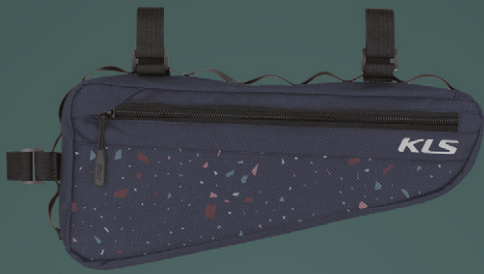

RECTANGLE

FRAME BAG

Made of recycled 600D Polyester / 210D Nylon
 3M reflective piping
 Inner compartment with small mesh pocket
 Adjustable Velcro strap fastening
VOLUME_ 0,9 L
DIMENSIONS_ 27 x 12 x 5 cm
COLORS_ flower, terrazzo



TILT

CYCLING SADDLE BAG

KLS TILT is a compact saddlebag roll bag to keep your essentials at hand. Thanks to durable Polyester 600D and special reinforcement, KLS TILT keeps the shape and lasts for years. Dedicated compartments as well as Velcro enclosure keeps the items safe and dry.
COLORS_ flower, terrazzo



T - system TOOLFREE

CHALLENGER

SADDLE BAG

Made of recycled 600D polyester
 Made of 600D polyester / Poly honeycomb / Tarpaulin
 3M reflective stripe
 Safety light attachment
 Patented T-system toolfree attachment / Velcro strap attachment

SIZES_

CHALLENGER T-SYSTEM/STRAP S
 volume 0,4 L, dimensions (17 x 7 x 8,5 cm)
 CHALLENGER T-SYSTEM/STRAP M
 volume 0,6 L (19 x 8 x 9,5 cm)
 CHALLENGER T-SYSTEM / STRAP L
 volume 0,9 L (21,5 x 9,5 x 9,5 cm)



ALPHA

TOP TUBE BAG

Made of 600D polyester / Poly honeycomb / Nylon 210D
 Two side pockets with small inner section
 Transparent top part keep smartphone up to 5,5 inch display
 3M reflective piping
 Velcro strap fastening
VOLUME_ 0,9 L
DIMENSIONS_ 14,5 x 13 x 11 cm



BRICK

TOP TUBE BAG

Made of recycled 600D Polyester
 Transparent top part keep smartphone up to 5,5 inch display
 Reflective piping
 Velcro strap fastening
VOLUME_ 1,1 L
DIMENSIONS_ 19 x 9 x 7 cm



RAIL

TOP TUBE BAG

Made of recycled 600D Polyester
 Two side pockets
 Reflective piping
 Velcro strap fastening
VOLUME_ 1,7 L
DIMENSIONS_ 21 x 12 x 4 cm (one side)



CELLY TOP TUBE BAG

Made of recycled 600D polyester/ Nylon 210D
Transparent top part keep smartphone up to 5,5 inch display
3M reflective piping
Velcro strap fastening
VOLUME _ 0,7 L
DIMENSIONS _ 10 x 18 x 9 cm
COLORS _ flower, terrazzo



GIRON HANDLEBAR BAG

Made of Tarpaulin / 210D Nylon
Main compartment with volume of 2 L
Transparent pocket for touch screen devices
Adjustable Velcro fastening to handlebar and stem
Suitable for bikes from 20"
VOLUME _ 2 L
DIMENSIONS _ 23 x 15 x 7 cm



RADIAN TOP TUBE BAG

Made of Tarpaulin / 210D Nylon
Velcro strap fastening
VOLUME _ 0,6 L
DIMENSIONS _ 21 x 4 x 9 cm



STRING SADDLE BAG

Made of Tarpaulin/ 210D nylon
Water resistant with zipperless closing system
3M reflective piping
Safety light attachment
Patented T-system toolfree attachment/
Velcro strap attachment

SIZES STRING S _
VOLUME _ 0,8 L
DIMENSIONS _ 17 x 9,5 x 9,5 cm

SIZES STRING M _
VOLUME _ 1 L
DIMENSIONS _ 18 x 11 x 10,5 cm



COBY II SADDLE BAG

Made of Tarpaulin
Suitable also for telescopic seatposts
Water resistant with zipperless closing system
Velcro fastening strap
VOLUME _ 1 L
DIMENSIONS _ 21,5 x 8,5 x 9 cm



MESSENGER MESSENGER BAG

Made of combination of Polyester 600D and Nylon 420D
Padded section for laptop up to 15,6 inches
Separate section for Tablet up to 10 inches
Section for charger, notebook, documents and other small goods
Easy to attach to travel bag handle
Length adjustable shoulder strap
VOLUME _ 7,5 L
DIMENSIONS _ 40 x 27 x 7 cm



KEEPER 50

CHILD SEAT

Suitable for 24" - 28" bicycle with a round shape saddle tube and size of 28 - 40 mm

Meets European standard EN 14344:2004

Child seat can be fixed on bicycles without rear racks with QR bracket

Ergonomic construction with extra cover of head and shoulders

Extra soft seat pad is removable and easy to clean

Adjustable 5-point seatbelts with soft cushion

Tool free adjustable footrest

Safety reflector on the back of the child seat

Handlebar for child to hold when riding or mount favorite toy for fun

Suitable for children above the age of approximately 9 months and weight up to 22 kg

MAXIMUM WEIGHT CAPACITY_ 22 kg

SIZES_ Approx. 37 x 53 x 67 cm

WEIGHT_ 2970 g



KEEPER 30

CHILD SEAT

Suitable for 24" - 28" bicycle with a round shape saddle tube and size of 28 - 40 mm

Meets European standard EN 14344:2004

Child seat can be fixed on bicycles without rear racks with QR bracket

Ergonomic construction with extra cover of head and shoulders

Seat pad is removable and easy to clean

Adjustable 5 - point seatbelts with soft cushion

Tool free adjustable footrest

Safety reflector on the back of the seat

Handlebar wrap around design for child to hold when riding for stability, or mount favorite toy for fun Suitable for children above the age of approximately 9 months and weight up to 22 kg

MAXIMUM WEIGHT CAPACITY_ 22 kg

SIZES_ Approx. 60 x 40 x 25 cm

WEIGHT_ 2930 g



CARGO FRONT BASKET

High quality front steel basket
Very handy for shopping
Quick release bracket
Click" bracket, easy to mount, with swing up handle
Fits for handlebars: 22,2 mm - 25,4 mm - 31.8 mm
Carries up to 5 kg
SIZES_ 34 x 25 x 25 cm

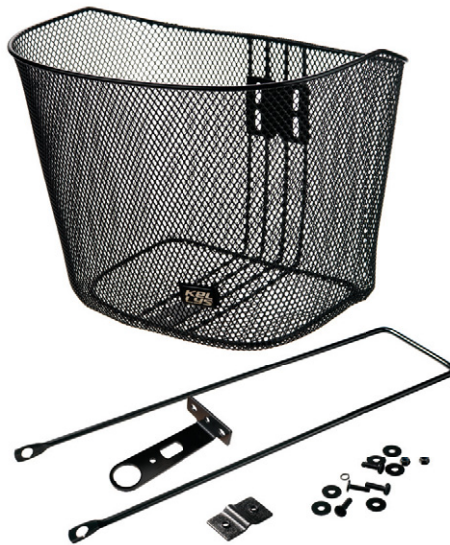

CITY FRONT FRONT BASKET

front steel basket with brace and grip under the headset nut
Easy to mount
Carries up to 5 kg
SIZES_ 35 x 25,5 x 26 cm

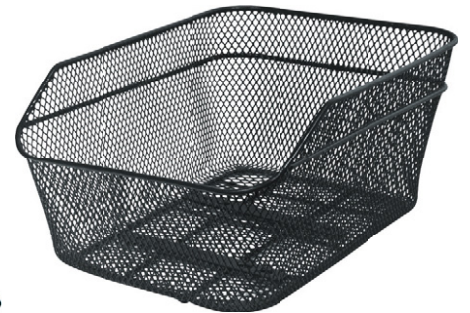

CITY REAR REAR BASKET

Black steel basket
Fixed mounting lengthwise on luggage carrier (including fixing material)
Carries up to 5 kg
SIZES_ 29 x 40 x 18 cm



RATTAN FRONT FRONT BASKET

High quality plastic rattan basket with brace and grip under the headset nut
Easy to mount
Carries up to 5 kg
SIZES_ 35 x 26 x 25 cm



RATTAN REAR REAR BASKET

High quality plastic rattan basket
Mounting with cable ties (including 6Pcs)
Carries up to 5 kg
SIZES_ 30 x 41 x 19 cm



LOAD FRONT FRONT BASKET

High quality plastic basket with brace and grip under the headset nut
Easy to mount
Carries up to 5 kg
SIZES_ 38 x 28 x 28 cm



LOAD REAR
REAR BASKET

High quality plastic basket
Mounting with cable ties (including 6Pcs)
Carries up to 5 kg
SIZES _ 34 x 45 x 26 cm



BUDDY
BICYCLE FRONT BASKET

Kids plastic basket
Carries up to 2 kg
SIZES _ 12 x 19 x 14,5 cm
DESIGNS AND COLORS _ koala - mint, sheep - white, lion - black, wasper - lime



CONVOY
BICYCLE RACK

For MTB / Cross (26 - 29") bikes
Material aluminum alloy
Suitable for disc and V-brakes
Max load 25 kg
With spring
Bracket for lights or reflector



BUNGEE
STRAP

Double banded elastic bike strap with hooks
Keeps your cargo tight on your bike rack



PORTER
BICYCLE RACK

Made of recycled 600D Polyester
Ø25,4 - 32 mm
Quick release TOOLFREE bracket
Material aluminum alloy
Rubber pad for a better grip and seat post protection
Max load 10 kg
Bracket for lights or reflector



DRIZZLE FRONT MUDGUARD

Front mudguard
Suitable for all types of frame tubes
Simple mounting on headtube
Fits 27,5" - 29" wheel size



DRIZZLE REAR MUDGUARD

Rear mudguard
Mudguard holder with an adjustable angle
Simple mounting on all seatpost diameters
Fits 27,5" - 29" wheel size



THUNDER MUDGUARD SET

Front and rear mudguard
Rear mudguard holder with two joints and an adjustable angle
Simple and quick mounting



FUSE MUDGUARD SET

Front and rear mudguard
Including two clamp diameters
For all frame types
Adjustable rear mudguard holder





KNIGHT

MUDGUARD SET

Front and rear mudguard
 Front mudguard with Turner system - Two position quick release system
 Rear mudguard with SQR System - Smart Quick Release System
 QR system for all seat posts diameters
 Rear mudguard holder with two joints and an adjustable angle



STORM

MUDGUARD SET

Front and rear mudguard for MTB and Cross
 Two ways of mounting on the seat tube:
 1. Fixation by adjustable mudguard bracket
 2. Fixation by flexible mounting strap
 Suitable for all frame types



WET

MUDGUARD SET

Front and rear mudguard set for MTB
 Fixation material included
 Easy to fit, metal stay for increased stability of rear mudguard
 Suitable for disc brakes thanks to special washer
 Fits 29" wheel size



RAINY

MUDGUARD SET

Front and rear mudguard for Cross and Trekking bikes with metal stays
 Excellent protection on wet or muddy terrain
 Fixation material included
 Easy to fit
COLORS_ black



FOGGY

MUDGUARD SET

Front and rear mudguard for children bikes
 Suitable for 20" wheels
 Fixation material included
 Easy to fit
COLORS_ black - grey, black - green, black - blue, white - pink, white - grey



IMPACT HILL

MUDGUARD

Universal FRONT or REAR mudguard with pre-cut holes for cable ties
 FRONT mudguard stopping the mud and dirt that's thrown into your eyes from the front wheel, also give additional protection to your fork seals.
 REAR mudguard protecting your suspension system (linkages, bearings, joints) and shock from getting dirty
 Suitable for forks from 80 mm to 200 mm travel, fits 26", 27.5" and 29" wheel size.



DOUBLEKICK KICKSTAND

For City / MTB / Cross (24" - 28") bikes
Two legs for increased stability
Rubber pads for a better grip and frame protection
INBUS adjustable



KICKDOWN KICKSTAND

For City / MTB / Cross (24" - 29") bikes
Plastic pads for a better grip and frame protection
TOOLFREE adjustable



KICKFLIP KICKSTAND

For City / MTB / Cross (24" - 28") bikes
For chain stays with fixed plate (40 mm width of holes)
Rubber pads for a better grip and frame protection
TOOLFREE adjustable



E-KICK KICKSTAND

For City / MTB / Cross (24" - 29") E-bikes
Directly mounted on the frame - hole distance 40 mm
For rear seat stay
TOOLFREE adjustable



KICKUP KICKSTAND

For City / MTB / Cross (24" - 29") bikes
Rubber pads for a better grip and frame protection
TOOLFREE adjustable



KICKER KICKSTAND

For MTB / Cross (26" - 28") bikes
Rubber pads for a better grip and frame protection
TOOLFREE adjustable



KICKBACK KICKSTAND

For City / MTB / Cross (24" - 29") bikes
rubber pads for a better grip and frame protection
TOOLFREE adjustable



KICKSTART KICKSTAND

For Junior / City (14" - 20") bikes
Rubber pads for a better grip and frame protection
TOOLFREE adjustable



E-KICKDOWN NEW

KICKSTAND

For City / MTB / Cross (24"-29") E-bikes
Plastic pads for a better grip and
frame protection
TOOLFREE adjustable



SENTRY

CHAIN STAY PROTECTOR

Flexible 3 mm thick neoprene cover to
prevent chain stay damage
Velcro strap for easy installation
SIZES _ M (280 x 110 mm)
SIZES _ L (280 x 130 mm)

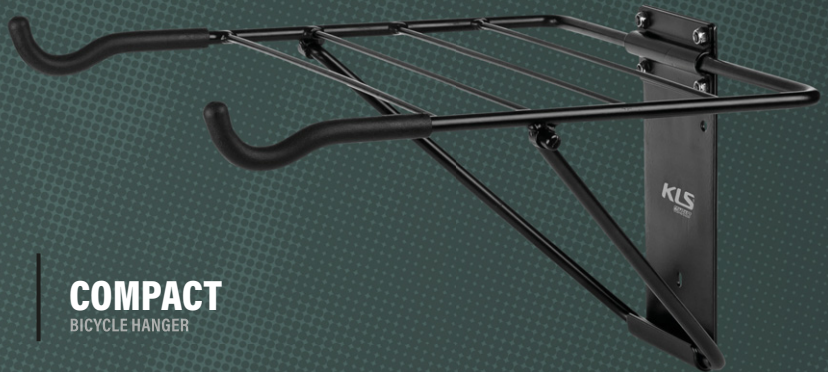

COMPACT

BICYCLE HANGER

Foldable wall hanger with space for accessories
Suitable for most bicycle frames.
Material aluminum alloy.
Max load 25 kg



HOW TO CHOOSE A LOCK

	SHORT STOPS	FEW HOURS	OVERNIGHT
VERY BUSY OR ABANDONED AREA	6-7 High Security	9-10 Extreme Security	9-10 Extreme Security
CITY CENTRES AND CLOSE SURROUNDINGS	4-5 Medium Security	6-8 High Security	9-10 Extreme security
SUBURBS	2-3 Light Security	4-5 Medium security	6-8 High Security
COUNTRYSIDE	1-3 Light Security	1-3 Light Security	4-5 Medium security

FOLDING

They are small in shape and easy to carry on your bike thanks to a bracket included with every lock. Folding locks offer great weight to strength ratio. Thanks to the connection points locks are easy to operate. Two keys are included with every FOLDING LOCK.

FOLD 90

FOLDING LOCK



FOLD 70

FOLDING LOCK



FOLD 50

FOLDING LOCK

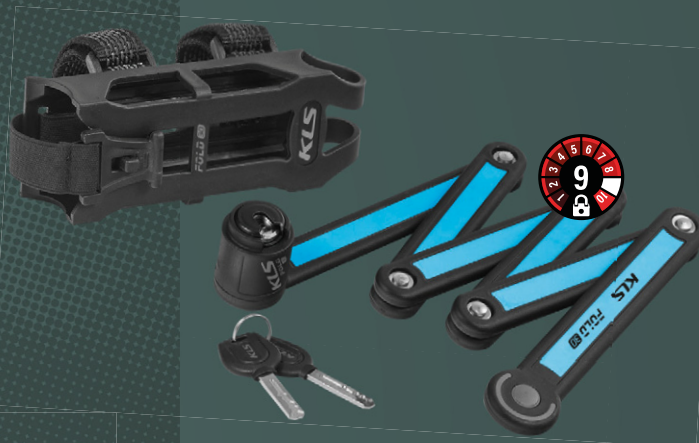

FOLD 30

FOLDING LOCK



COLORS_ grey, blue



U-LOCKS

Offers extreme security for your bikes. They are easy to carry on the frame of the bicycle. Dust cap on lock cylinder prevent dust gathering at the locking area. Plastic cover will protect your bike against scratches.

BOLD STEEL U-LOCK



AREST STEEL U-LOCK



CHAIN LOCKS

These are heavy duty locks offering maximum security for your bicycle. You can easily carry them around the seatpost. Polyester sleeve protects your bike from scratches. Chainlocks have two options to choose from - either key system or combination dial.



CHAINLOCK 10 STEEL CHAIN LOCK

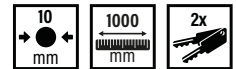

SPIRAL CABLE LOCKS

Locks with great weight to strength ratio. They are easy to carry thanks to the bracket included with every lock. New technology key and lock cylinder. Plastic cover on inner wire will keep your bike scratch free. Two keys are included with every lock.

CHAINLOCK 8

STEEL CHAIN LOCK

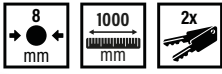

CHAINLOCK 6

STEEL CHAIN LOCK

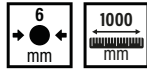

CHAINLOCK 4

STEEL CHAIN LOCK

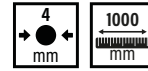

HARDCOIL

SPIRAL CABLE LOCK



RECOIL

SPIRAL CABLE LOCK



COIL

SPIRAL CABLE LOCK





COMBINATION SPIRAL CABLE LOCKS

These light weight locks with small size cable are easy to store and carry on bicycle. Plastic cover on inner wire will keep your bike scratch free and thanks to dial system you won't need to carry around the lock keys.

ENCODE

COMBINATION SPIRAL CABLE LOCK



CODE

COMBINATION SPIRAL CABLE LOCK



CABLE LOCKS

These light locks with small size cable are easy to store and carry on bicycle. They offer great weight to strength ratio. Mostly colourful locks aimed for city riders.



CRYPT

COMBINATION CABLE LOCK

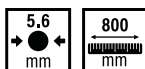

ZIPLOCK NEW LOCK

Handy lightweight lock inspired by system of zip tight is easy and fun to use. Plastic body of the lock keep you bicycle scratch free while the steel plate inside makes it strong enough to lock your bike and keep it safe. 4-code resettable number combination is a handy keyless solution and it's length of 45cm makes it your best friend to put it on bike or bag and carry it with you.





SUNNY

CABLE LOCK WITH SILICON COVER

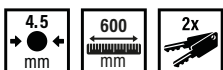

JOLLY

CABLE LOCK COVERED BY SOFT RUBBER

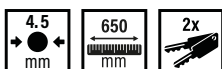

KIDDY

CABLE LOCK



BILL

SPIRAL CABLE LOCK

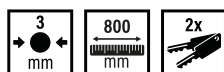

CODECASE

WIRE POCKET LOCK

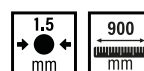

CABLE

EXTENSION CABLE

Extends U-Lock's protection to all part of bike

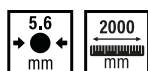



BUZZER

BICYCLE BELL

Brass shiny rainbow bicycle bell with shrill sound
Easy to install and remove
360 degree turnable
With metric screw
COLORS_ rainbow



BANG 10

BICYCLE BELL

Lightweight bicycle bell with extra loud stainless top and steel spring
Easy to install and remove
Mountable in various positions
360 degrees turnable
With metric screw
COLORS_ black, silver, red, blue



BANG 30

BICYCLE BELL

Lightweight bicycle bell
Alloy top with plastic base and lever
Quick release - easy to install and remove
TOP SIZE_ 32 mm
COLORS_ black



BANG 50

BICYCLE BELL

Lightweight bicycle mini bell with shrill sound
Easy to install and remove
Mountable in various positions
360 degree turnable
With metric screw
TOP SIZE_ 23 mm
COLORS_ gold, black



BANG 50 COFFEE

BICYCLE BELL

Lightweight bicycle mini bell with shrill sound
Toolless installation
360 degree turnable
TOP SIZE_ 23 mm
COLORS_ coffee



BANG 70 BLACK

BICYCLE BELL

High end brass bell with resonant sound
Easy to install and remove
With metric screws
TOP SIZE_ 50 mm
COLORS_ matt black



BELL 20

BICYCLE BELL

Lightweight bicycle bell with ringing sound
Alloy top with plastic base and lever
Easy to install and remove
With metric screw
TOP SIZE_ 53 mm
COLORS_ black, silver



BELL 80

BICYCLE BELL

Steel design bicycle bell with the matt finish. Easy to install and remove.
TOP SIZE_ 80 mm
COLORS_ deep blue, antique red



KIDDIE

BICYCLE BELL

KIDDIE is a bicycle bell with colorful designs for children. It's made of durable steel and it has easy installation.
DESIGNS_ koala, sheep, lion, wasper



BLOOM NEW

E-BIKE AIRTAG BICYCLE BELL

Copper black matt bicycle bell with shrill sound
Certified sound >85dB
Integrated airtag holder
Easy to install and remove
Suitable for handlebar diameter of 22.2mm
COLOR_ black



BELL 60

BICYCLE BELL

Steel design bicycle bell with the matt finish. Easy to install and remove.
TOP SIZE_ 60 mm
COLORS_ tropical green, sky blue, candy pink



BELL 60 KIDS

BIG BICYCLE BELL AIMED FOR CHILDREN

Easy to install and remove
With metric screws
TOP SIZE_ 60 mm
COLORS_ red, blue



PATROL BICYCLE MIRROR

High quality HD convex mirror ensures great observation angle and great view
It's universal for left and right side with fully adjustable viewing angle. It's made of eco-friendly high impact nylon. With easy installation and secure mirror fixation into the bar ends.

COLORS_ black



BACKSIGHT BICYCLE MIRROR

Convex mirror ensuring great observation angle
Fibre plastic arm for improved break resistance
Easy installation with secure mirror fixation on the handlebars

Fits on 22 mm handlebar

COLORS_ black



FEND BICYCLE MIRROR

FEND is a compact mirror for bicycle, that helps increase safety when riding. It is suitable for road, trekking and MTB bikes.

COLORS_ black



POISON
GRIPS

Alloy lock rings for slip-free performance and easy mounting
 Extra soft materials for extra comfort
 Rough design for tight grip and ultimate ride control
 Plastic plugs included
OUTER DIAMETER _ 030 mm
WIDTH _ 135 mm
COLORS _ azure blue, black, candy red, lawn green, lime, grey/black, orange/black, pink/black, turquoise/black, dijon yellow/black, dark violet/black
OPTIONS _ single lock - on, double lock - on

SWARM
GRIPS

Built-in lock ring for slip-free performance and easy mounting
 Extra soft materials for extra comfort
 New design for extra comfortable and strong grip
OUTER DIAMETER _ 030mm
WIDTH _ 135mm
COLOR _ Black
OPTIONS _ Single Lock-On

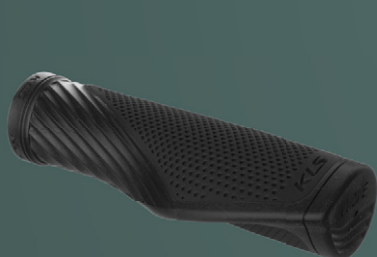

WAVE
GRIPS

Ergonomic shape ensure maximum comfort
 Available also in single-lockring version for slip-free performance and easy mounting available
 Available also in short version for one-sided twist grip shifts
 2 density kraton rubber for soft touch and shock absorption
WIDTH _ 135 mm
COLORS _ grey, black
OPTIONS _ with lock ring, without lock ring, short

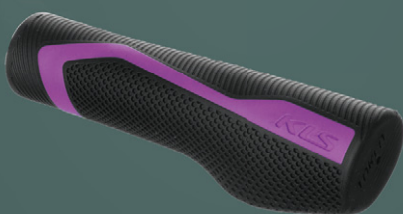

TOKEN
GRIPS

Semi ergo shape
 Combines comfort of ergo grip yet can handle rough MTB terrain
 Available also in single-lockring version for slip-free performance and easy mounting available
 2 density kraton rubber for soft touch and shock absorption
WIDTH _ 135 mm
COLORS _ red, green, blue, turquoise, purple, yellow, orange, white, black
OPTIONS _ with lock ring, without lock ring



ADVANCER
GRIPS

2 density kraton rubber for soft touch and shock absorption
 Designed for tight grip and ultimate drive control
OUTER DIAMETER _ 031 mm
WIDTH _ 130 mm
COLORS _ black, blue, green, orange, pink, red, sand brown, turquoise, white, yellow



HOLLANDGRIP

GRIPS

Ergonomic Shape
Designed for stylish ride through your city
Provides excellent grip with optimal control
Available also in short version for one-sided twist grip shifts
WIDTH_ 132 mm, 132 / 92 mm
COLORS_ brown, black
OPTIONS_ without lock ring, short



SHORTGRIP

GRIPS

Kraton rubber absorbs vibration
Designed for Twist-Grip systems
WIDTH_ 90 mm
COLORS_ black

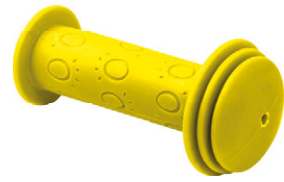

KIDDO'

GRIPS

Slip protection helps your youngest to keep hands on handlebars at all times
Designed to fall in love with instantly
WIDTH_ 95 mm
COLORS_ red, green, blue, yellow, pink, purple, white, black

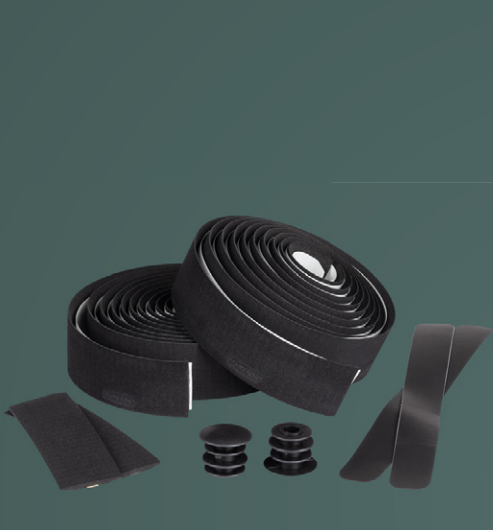

GRAVEL TAPE

HANDLEBAR TAPE

Extra thick material 3.5 mm for maximum comfort
Brushed surface ensures that your hands stay in place
EVA base with VexGel™
End-plugs, short stripes and flexible finishing tapes included
COLORS_ black



BASTOGNE

HANDLEBAR TAPE

Microfiber with EVA base with VexGel™ adhesive for ultimate vibration absorption and durability
Diamond pattern for enhanced grip even without gloves
Easy cleaning surface
End-plugs, short stripes and flexible finishing tapes included
COLORS_ black, blue, red, white



TRENTO

HANDLEBAR TAPE

Durable EVA tape with VexGel™ adhesive ultimate vibration absorption
Tacky soft touch surface for all-day long comfort
Easy cleaning surface
End-plugs, short stripes and flexible finishing tapes included
COLORS_ black, blue, jersey rojo red, maillot jaune yellow, green, maglia rosa pink, neon yellow,



RIDER

SERVICE & CARE

BICYCLE / GRIPS, HANDLEBAR TAPES

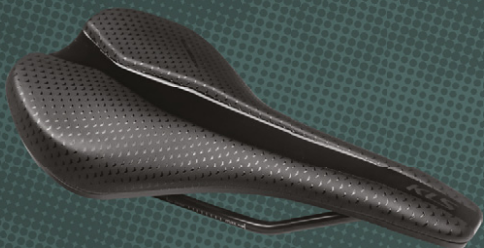
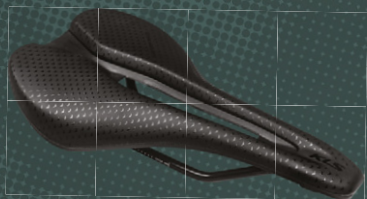

AVENGER MTB & RACE NEW SADDLE

Saddle designed for Cross-Country riders in two options
Race version has cutout zone in the middle to release pressure on sensitive body area and save some weight
MTB version with covered cutout zone for harsh conditions improved support
Saddle available in two widths for better fit
Scale for precise adjustment
SIZE _255 x143mm
COLOR _Black



PUFER & PUFER LITE NEW SADDLE

Saddle Puffer (Lite) makes great compromise in between performance and comfort.
Ergonomic rear part elevated to offer greater grip and stability
Rails made of carbon steel and foam with ideal density, that makes your ride enjoyable.
Comes in two widths 145mm and 155mm for better fit and comfort.
Its total length is only 250mm following latest trends for lower weight and support only where needed.
SIZES _250 x 155 mm / 250 x 145 mm
COLORS _black



GRAILON NEW SADDLE

The base of Grailon saddle is designed similarly to road saddles, enriched with a thicker layer of foam, that absorbs vibrations and shocks during both on-road and off-road rides. Rear part is connected with a bridge, allowing better vibration damping. It has a shortened front part and ergonomically selected middle part.
SIZES _240 x 140 mm
COLORS _Black



SPEAR SPEAR LITE SADDLE

Saddle designed for performance riders who seek the lightweight comfortable option.
Cutout zone in the middle releases pressure on sensitive body area
Flex rail technology reduces vibrations
Saddle available in two widths for better fit
Scale for precise adjustment
SIZES _250 x 155 mm / 245 x 144 mm
COLOR _black



NUBULAR NUBULAR LITE SADDLE

Designed for trekking and touring bikes and e-bikes in these categories
Memory Foam provides perfect adherence with body
Comfort+ density foam minimizes vibrations which makes the saddle comfortable during longer rides.
Saddle available in two widths for better fit
Scale for precise adjustment
SIZES _265 x 190 mm / 264 x 162 mm
COLOR _black



COMFORTLINE

SADDLE

Made to ensure maximum comfort
 Zone cut releases pressure in most sensitive area
 Hi-Density foam
 Scale for precise adjustment
SIZE 262 x 191mm
COLORS black



CROSSLINE

SADDLE

Designed for Cross-Country adventures
 Side protection ensures longer durability
 Zone cut releases pressure in most sensitive area
 Hi-Density foam
 Scale for precise adjustment
SIZES 283 x 172 mm
COLOR black



DIVERSA

SADDLE

Designed to perfectly fit woman ergonomics
 For everyday bike ride anywhere
 Hole releases pressure in most sensitive area
 Hi-Density foam
 Scale for precise adjustment
SIZES 274 x 158 mm
COLORS black, white



TIMBER

SADDLE

Gel combined with Hi-Density foam
 Side protection ensures longer durability
 Scale for precise adjustment
 For everyday bike ride anywhere
SIZES 275 x 163 mm
COLOR black



DRIVELINE

SADDLE

Designed for daily MTB adventures
 Zone cut releases pressure in most sensitive area
 Hi-Density foam
 Scale for precise adjustment
SIZES 277 x 162 mm
COLORS red, green, blue, orange, black



GEL

SOFTLINE SADDLE

Gel combined with high density foam
Side protection ensures longer durability
Scale for precise adjustment
For everyday bike ride anywhere
SIZES _ 257 x 187 mm
COLORS _ black



TREKKINGLINE TREKKING SADDLE

Made to ensure maximum comfort
Zone cut releases pressure in most sensitive area
Hi-Density foam
Scale for precise adjustment
SIZES _ 265 x 200 mm



GEL



CITYRIDE SADDLE

Gel combined with high density foam
Elastomer shock absorber system
Scale for precise adjustment
Designed for everyday urban ride
SIZES _ 260 x 225 mm
COLORS _ black, brown



HARLEQUIN CITY SADDLE

Designed to cruise the Urban area
Double spring coil for a smoothest ride
Zone cut releases pressure in most sensitive area
Scale for precise adjustment
SIZES _ 265 x 255 mm
COLORS _ black, brown



VAN KELLYS SADDLE

High density foam
Steel spring for comfort suspension
Scale for precise adjustment
Designed to cruise your city
SIZES _ 250 x 210 mm
COLORS _ brown, black



DRIVELINE JUNIOR

SADDLE

Designed for everyday bike ride anywhere
 Made to ensure maximum comfort
 Hi-Density foam
 Scale for precise adjustment
SIZES _ 275 x 163 mm
COLORS _ grey



WASPER

JUNIOR SADDLE

Designed for everyday bike ride anywhere
 Handle for easy pick up of the bike
 Hi-Density foam
 Scale for precise adjustment
SIZES _ 245 x 145 mm
COLORS _ blue, grey, red, teal



EMMA

JUNIOR SADDLE

Designed for everyday bike ride anywhere
 Handle for easy pick up of the bike
 Hi-Density foam
 Scale for precise adjustment
SIZES _ 245 x 145 mm
COLORS _ pink, purple, turquoise

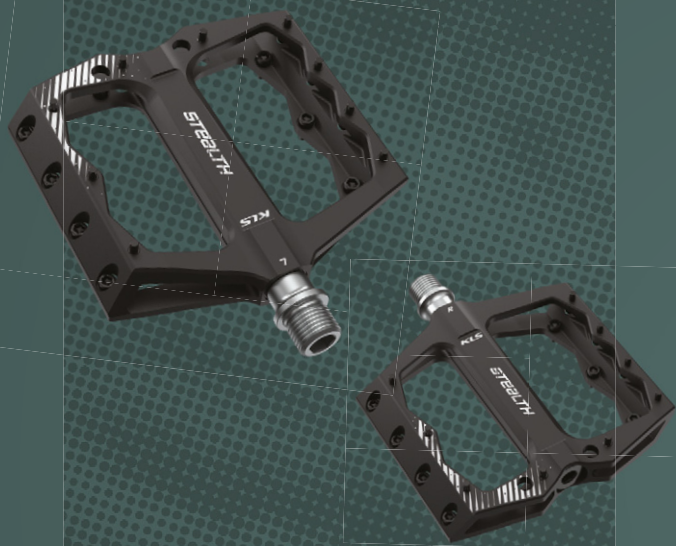

STEALTH II ^{NEW} PEDALS

Platform pedal with a concave body
CNC machined pedal made of 6061 aluminium alloy
Replaceable pins
Body: CNC aluminium
Axle: CNC-machined Cr-Mo
Bearing: LSL Bushing and Sealed bearing System
SIZE _ 105 x 103mm
WEIGHT _ 400g



FLAT 50 PEDALS

Aluminum pedal for BMX/MTB
Pins: Replaceable grip pins and 2 extra pins included.
Axle: CNC-machined Cr-Mo
Body: Die-cast aluminum
Bearing: LSL Bushing & Sealed
SIZES _ 115 x 108 mm
WEIGHT _ 550 g
COLORS _ black, lime, orange



FLAT 50 BB PEDALS

Aluminum pedal for BMX/MTB
Pins: Replaceable grip pins and 2 extra pins included.
Axle: Boron steel
Body: Die-cast aluminum
Bearing: Ball bearings
SIZES _ 115 x 108 mm
WEIGHT _ 550 g
COLORS _ black, lime, orange

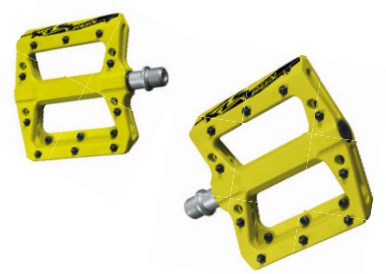

REIN PEDALS

BMX/MTB platform pedals made of thermoplastic reinforced by fiber glass
Axle: Cr-Mo steel
Bearing: LSL bushing & sealed
Pins: Replaceable grip pins, 2 extra pins included
DIMENSIONS _ 100 x 95 x 18 mm
WEIGHT _ 350 g / pair
COLORS _ black, yellow, green



TRAIL 30

PEDALS

Aluminium pedal for Cross/City
Body: Aluminium with non-slip rubber surface
Axle: Boron
Bearing: Ball bearings
SIZES_ 108 x 84 mm
WEIGHT_ 390 g



TRAIL 10

PEDALS

Plastic pedal for City/Cross
Body: Plastic
Axle: Boron
Bearing: Ball bearing
SIZES_ 109 x 75 mm
WEIGHT_ 384 g



MASTER

PEDALS

Aluminium pedal for MTB/Cross
Body: Aluminium
Axle: Cr-Mo
Bearing: Ball bearing
SIZES_ 95 x 78 mm
WEIGHT_ 264 g



CLIPPER

PEDALS

Aluminum SPD Compatible pedal for MTB
One side SPD cleat, stable body platform on the other
Body: Aluminium
Axle: Cr-Mo
Bearing: Sealed
SIZES_ 105 x 66 mm
WEIGHT_ 366 g



FLAT 40 NEW

PEDALS

Aluminum low profile platform pedal without pins for E-bikes
Body: Die-cast aluminum with sand paper
Axle: CNC-machined Cr-Mo
Bearing: LSL Bushing and Sealed bearing System
SIZE_ 110 x 88 mm
WEIGHT_ 436g



FLAT 30

PEDALS

Aluminum low profile platform pedal for MTB/BMX
Body: Die-cast aluminum
Axle: Boron
Bearing: SPB (Smooth Polymer Bearing)
SIZES_ 113 x 110 mm
WEIGHT_ 425 g



FLAT 20

PEDALS

Plastic platform pedal for MTB/BMX
Body: Plastic
Axle: Boron
Bearing: SPB (Smooth Polymer Bearing)
SIZES_ 110 x 100 mm
WEIGHT_ 296 g



HANDLEBARS	RISEBAR	FLATBAR	RISE	SWEEP	WIDTH	DIAMETER	FINISH	TECHNOLOGIES
DH 70	•		1"	Back: 9° / Up: 5°	810 mm	31.8 mm O/S	sand blasted black	AL 6061, DOUBLE BUTTED
ALM/EN 80	•		18 / 35 mm	Back: 9° / Up: 5°	780 mm	35 mm	sand blasted black	AL 6061, DOUBLE BUTTED, 35 mm
ALM/EN 70	•	•	0,5" / 1" / 1,5" / 2"	Back: 9° / Up: 5°	780 mm	31.8 mm O/S	sand blasted black	AL 6061, DOUBLE BUTTED
ALM/EN 30	•		18 mm	Back: 9°	780 mm	Ø31.8 / 35 mm	sand blasted black	AL 6061, 35 mm
ADVANCED XC 70	•	•	0 / 15 mm	Back: 5° / Up: 4°	720 mm	31.8 mm O/S	sand blasted black	AL 6061, DOUBLE BUTTED
ACTIVE 70	•	•	0 / 18 mm	Back: 5 / 9°	720 / 760 mm	Ø31.8mm	sand blasted black	AL 6061
ACTIVE XC 70	•	•	0 / 15 mm	Back: 5° / Up: 4°	720 mm	31.8 mm O/S	sand blasted black	AL 6061
CRX 70	•		15 mm	Back: 5° / Up: 4°	640 mm	31.8 mm O/S	sand blasted black	AL 6061, DOUBLE BUTTED
CRX 50	•		30 mm	Back: 9° / Up: 0°	640 mm	25.4 mm	sand blasted black	AL 6061

STEMS	ANGLE	DIAMETER	EXTENSION	QUILL LENGTH	STEERER TUBE DIAMETER	FINISH	TECHNOLOGIES
ALM/EN 70	0°	31.8 mm, 35 mm	35 mm	-	28.6 mm	CNC anodized black	CNC MACHINED, AL 6061, 3D FORGED, T6, 35 mm
ALM/EN 50	0°	31.8 mm O/S	40, 50, 60 mm	-	28.6 mm	sand blasted black	AL 6061, 3D FORGED
ALM/EN 30	0°	31.8 mm, 35 mm	35 mm	-	-	sand blasted black	AL 6061, 3D FORGED, 35 mm
ULTIMATE XC 70	7°	31.8 mm O/S	60, 70, 80, 90, 100, 110, 120, 130 mm	-	28.6 mm	sand blasted black	AL 6061, 3D FORGED, T6
ADVANCED XC 70	7°	31.8 mm O/S	80, 90, 100, 110, 120, 130 mm	-	28.6 mm	sand blasted black	AL 6061, T6
ACTIVE 70	7°	31.8 mm O/S	40, 50, 60, 70, 80, 90 mm	-	-	sand blasted black	AL 6061, 3D FORGED
ACTIVE XC 70	6°	31.8 mm O/S	60, 70, 80, 90, 100 mm	-	28.6 mm	sand blasted black	AL 6061, 3D FORGED
CRX 80	90 - 140°	31.8 mm O/S	105 mm	-	28.6 mm	sand blasted black	AL 6061, 3D FORGED
CRX 70	0 -- +/-60°	31.8 mm (95, 110, 125 mm)	25.4 mm (90, 110, 125 mm)	-	28.6 mm	sand blasted black	AL 6061, 3D FORGED
CRX 50 QUILL	0 - 60°	25.4 mm	100 mm	180 mm	22,2 mm	sand blasted black	

BAR ENDS	SHAPE	LENGTH	FINISH
ADVANCED	Ergonomic shape	One piece 6061-T6 aluminum alloy	110 mm sand blasted black
CRX 30	Ergonomic shape	One piece 6061 aluminum alloy	160 mm sand blasted black

SEAT POST CLAMPS	DIAMETER	FINISH	TECHNOLOGIES
QR PIN	35, 31.8 mm	sand blasted black	AL 6061
HEX PIN	35, 31.8 mm	sand blasted black	

SEAT POSTS		DIAMETER	LENGTH	FINISH	TECHNOLOGIES
SHIFT	Dropper seat post with remote lock out (inner routing)	30.9 mm	402 mm (125 mm travel), 445 mm (150 mm travel)	hard anodized black	
ADVANCED XC 70	Forged head	272, 30.9, 31.6 mm	400 mm	sand blasted black	
ACTIVE XC 70	Die casted clamps	272, 30.9, 31.6 mm	400 mm	sand blasted black	
CRX/URB 70 S	Suspension Seat Post Forged head	272, 30.6, 31.6 mm	350 mm	sand blasted black	
CRX/URB 70 SL	Suspension Seat Post Forged head	272, 30.6, 31.6 mm	350 mm	sand blasted black	
CRX/URB 30		272, 30.9 mm	400 mm	sand blasted black, natural silver	

FORK EXTENDER		LENGTH	EXTENSION	STEERER TUBE DIAMETER	FINISH	TECHNOLOGIES
FORKY	Includes 4 pcs of 5 mm spacers and 1 pc of 10 mm spacer	120 mm	70 mm	28,6 mm	sand blasted black	



AL 7050

Strongest aluminum alloy, commonly used in rock-climbing equipment, hang glider frames, military, automotive and, of course, bicycle industry. Toughest material, but difficult to weld. That's why it is used mostly for Handle Bars only.



AL 6061

Aluminum alloy commonly used in home build or hobby aircraft, yacht constructions or scuba tanks. Provides very good ratio between strength and affordability.



DOUBLE BUTTED

2 thicknesses of material are combined to provide best of both - strength and lightweight. Where the material needs to stand against strong pressure, it is thickened to provide extra strength. On points where the material is not handling that much pressure, it is thinned to reduce unnecessary weight.



T6

process of increasing the material hardness by heating the material to a certain temperature for certain period of time. Times and temperatures may vary based on materials used. This process arranges atoms in molecular structures which greatly increase the strength of material. Also called "Aging Process"



3D FORGING

Solid block of heated aluminum is compressed into desired mould.

Advantage of this technology of forging is that no welding needs to be used, so the component is lighter and stronger in the end.



CNC

Computer Numerical Control - is the automation of tools through

commands which are entered in digital form. This means better precision and control over the tools. This also allows for more complicated shapes to be made, which otherwise wouldn't be possible by using the die-casting method. In the end the products can be "nicer", lighter (because CNC removes material from places where it is not needed), and which fits very precisely.



ICR

Routing of cable from dropper post to remote lever is done through bicycle frame. It improves overall aesthetics and lowers maintenance interval for cable. It is recommend to check compatibility of frame with this technology.





S
W
I
T
C
H
F
L
O
W

SWITCHFLOW

BICYCLE FLOOR PUMP

KLS SWITCHFLOW is a floor pump for every type of valve (Dunlop, Schrader and Presta). It's sturdy aluminium body makes pumping easy and safe. Thanks to large and precise manometer and ergonomic handle setting up the desired tyre pressure is easy and comfortable. On the top of that KLS SWITCHFLOW is equipped with hi-volume and hi-pressure switch - hi-volume for quick filling up the empty tyre, hi-pressure for setting the right pressure with ease.





AIRFLOW ONE

FLOOR PUMP

Alloy service pump with Airtank
Inflates tubeless ready tires
Switchable Schrader/Presta/
Dunlop
Ergonomic handle for comfortable
pumping
Stable die-cast base covered by
rubber for even better stability
Top mounted gauge

MAXIMUM PRESSURE_
240 psi / 18 bar



MAGNUM

FLOOR PUMP

Alloy floor pump
Pressure gauge
Dual head for Schrader/Presta/
Dunlop
Ergonomic handle with rubber
grip zones
Stable base

MAXIMUM PRESSURE_
160 psi / 11 bar



TWISTER PRO

FLOOR PUMP

Light weight plastic pump
Wider shaft for easy pumping
Dual head for Schrader/Presta/
Dunlop
Wide base for stability
Half-height big round gauge

MAXIMUM PRESSURE_
160 psi / 11 bar



TWISTER

FLOOR PUMP

Light weight plastic pump
Wider shaft for easy pumping
Dual head for Schrader/
Presta/Dunlop
Wide base for stability

MAXIMUM PRESSURE_
160 psi / 11 bar





DOUBLY PRO 50

ERGONOMIC ALLOY MINI PUMP

Dual head for Schrader/Presta/Dunlop
Telescopic
Ergonomic T-Lock handle
WEIGHT_ 153 g
LENGTH_ 265 mm
MAXIMUM PRESSURE_ 100 psi / 7 bar



DOUBLY PRO 30

ERGONOMIC ALLOY MINI PUMP

Dual head for Schrader/Presta/Dunlop
Ergonomic T-Lock handle
WEIGHT_ 137 g
LENGTH_ 265 mm
MAXIMUM PRESSURE_ 80 psi / 5 bar



DOUBLY PRO 10

ERGONOMIC PLASTIC MINI PUMP

Dual head for Schrader/Presta/Dunlop
Telescopic
Ergonomic T-Lock handle
WEIGHT_ 128 g
LENGTH_ 265 mm
MAXIMUM PRESSURE_ 100psi / 7 bar



CLASSIC

TRAVELPUMP

Aluminium alloy pump
Combination of minipump with performance of floor pump
Hose ergonomically nested in oval
Reversible head for Schrader/Presta valve
Foldable T-handle
Integrated metal pedestal, including frame bracket
WEIGHT_ 209 g
MAXIMUM PRESSURE_ 120 psi / 8 bar



DRIFT

MINIPUMP

Minipump suitable for MTB
Made by CNC technology
Patented auto switching dual head fits Schrader/Presta
Big barrel
LENGTH_ 215 mm
MAXIMUM PRESSURE_ 80 psi / 5 bar



OMNI

MINIPUMP

All in one mini pump
Shock/Schrader/Presta/Dunlop
Multi-directional hose
Bleeder for fine tuning pressure
Gauge for Bar/PSI reading
High pressure - Big volume switch
WEIGHT_ 218 g
LENGTH_ 260 mm
MAXIMUM PRESSURE_ 300 psi



AIRSHIFT NEW

MINIPUMP

Aluminium alloy mini pump
Clever Twin valve for all types of valves (Presta, Schrader and Dunlop)
Switchable mode for High Volume and High Pressure
CNC machined handle and barrel
LENGTH_ 190 mm
MAXIMUM PRESSURE_ 110Psi/8bar
WEIGHT_ 105 g



AIRJET NEW

MINIPUMP

Pocket size aluminium alloy mini pump
Clever Twin valve for all types of valves (Presta, Schrader and Dunlop)
Switchable mode for High Volume and High Pressure
Extractable hose with 90 degree connector
CNC machined handle and barrel
Soft material on barrel and top cap for comfortable touch
Easy storage in jersey pocket
LENGTH_ 150 mm
WEIGHT_ 105 g
MAXIMUM PRESSURE_ 110Psi/8bar



PULSE DUAL NEW

MINIPUMP

Plastic mini pump
Dual head for Presta and Schrader/Dunlop valves
Thumb lock lever
LENGTH_ 250 mm
WEIGHT_ 96 g
MAXIMUM PRESSURE_ 80Psi/5bar



COVERT

PUMP

Compact mini floor pump usable also as portable hand pump
 1" pop-out precise hideable gauge
 - sliding out by stepping down metal footpad
 18 mm alloy telescopic barrels for Big-Volume/Hi-Pressure modes
 Pinch-Free T-handle
 CNC valve core and cap
 Patented auto-switching Twin Head fits schrader/presta with thread for valve engagement
 Valve head with plugs against dust
LENGTH_ 300 mm
WEIGHT_ 216 g
MAXIMUM PRESSURE_ 120 psi / 8 bar



E-FLOW

NEW
ELECTRIC PUMP

Lightweight and portable mini electric pump
 Inflates 6 regular (28 inch) bikes tires in one charging cycle
 Cooling holes on the bottom of the pump to prevent overheating
 Pre-set pressure option and automatic stop
 360 degree rotating hose with Presta/Schrader valves
 Battery indicator
 USB port type C
SIZE_ 100mm x 65 x 38 mm
WEIGHT_ 350g
MAXIMUM PRESSURE_ 150psi/10bar



KINDLE

ERGONOMIC MINIPUMP

Compact and lightweight mini pump
 Plastic body and large ergonomic handle
 Universal pump head for all types of valves
 Thumb Lock system
 Including bracket
WEIGHT_ 100 g
LENGTH_ 240 mm
MAXIMUM PRESSURE_ 80 psi / 5 bar



SHOCKER 70

HIGH-PRESSURE PUMP

Alloy high pressure pump
 With pressure gauge
 Coverec fine tuning pressure bleeding valve
 Swivel hose for easy pumping
 Ergonomic handle
LENGTH_ 260 mm
WEIGHT_ 190 g
MAXIMUM PRESSURE_ 300 psi / 20 bar



SHOCKER 50

HIGH-PRESSURE PUMP

With pressure gauge
 Fine Tuning pressure bleeding valve
 2-stage non-leakage valve
 Swivel hose for easy pumping
 Plastic upper & lower handles
 Pinch-Free locked T-handle
LENGTH_ 260 mm
WEIGHT_ 190 g
MAXIMUM PRESSURE_ 300 psi / 20 bar



FLOWCONTROL

BICYCLE CO2 ADAPTOR

KLS FLOWCONTROL is a CO2 cartridge adaptor to pump repaired tyres/tubes. Thanks to flow valve it's easy to control the flow of CO2 to make pumping easy and safe.

BICYCLE CO2 CARTRIDGE
 KLS CO2 CARTRIDGE to pump repaired tyres/tubes. Fits KLS FLOWCONTROL.



S E R I E S

SERVICE & CARE



TAKE CARE OF WHAT BRINGS YOU JOY.

The components of your bike are exposed to heavy loads and wear, especially during aggressive riding or in difficult conditions. To keep your bike ready for next adventure and give you as much joy as possible, proper service with the KLS top quality tools and lubricants is essential. Get ready for the next adventure!

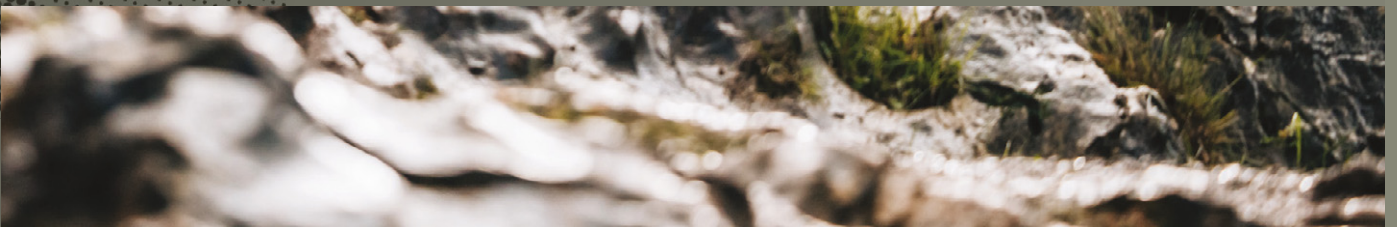



KLS HANDY

BICYCLE MULTITOOl

HANDY is a multitool with everything necessary for longer ride. It is made of quality chrome vanadium steel (CR-V) and plastic.
Tool includes:

2 mm hex	3 mm hex	4 mm hex
5 mm hex	6 mm hex	8 mm hex
T25 Torx	Flat head screwdriver	Philips 2 head screwdriver
Chain quick link holder	2 pcs tire levers	Chain tool
Spoke wrench 3.33 / 3.45 / 3.55 / 4.20 mm		
Chain holder	Presta valve core tool	



ADROIT

FOLDING TOOL

Compact minitool with chain tool
Hardened chromevanadium steel (Cr-V)
19 functions, includes:

Chain tool with chain hook	Tire levers	2 mm hex
2.5 mm hex	3 mm hex	4 mm hex
5 mm hex	6 mm hex	8 mm hex
Box wrench 8 mm	Box wrench 9 mm	Box wrench 10 mm
Spoke wrench 3.2 / 3.3 / 3.5 mm		
T25 Torx	Philips head screwdriver	Flat head screwdriver



GUIDE

FOLDING TOOL

Compact, light weight (105,5 g) minitool with chain tool
Hardened chromevanadium steel (CR-V)
15 functions, includes:

Chain tool	2.5 mm hex	3 mm hex
4 mm hex	5 mm hex	6 mm hex
8 mm hex	Philips head screwdriver	
Flat head screwdriver		T25 torx
Spoke wrench 3.2 / 3.3 / 3.4 / 3.9 mm		
Mavic spoke wrench		

BARTOOL NEW

HANDLEBAR INSERT TOOL KIT

Handlebar insert tool kit which is crafted from durable aluminum alloy 6061 in combination with fiber plastic composite. Engineered to fit handlebars with inner diameters ranging from 18.5mm to 20.7mm, BARTOOL ensures compatibility with most of handlebars.

Chain tool 6-12 speed	2 mm hex	2.5 mm hex
3 mm hex	4 mm hex	5 mm hex
6 mm hex	8 mm hex	T10 Torx
T25 Torx	Flat head screwdriver	Philips head screwdriver
Spoke wrench 3.23 / 3.3 / 3.45 mm		
5 pcs 1.5x50 mm tubeless plug	Tubeless tire repair tool including application fork and file	





CHAINEY
FOLDING TOOL

Compact minitool with chain tool, hardened chromevanadium, steel (CR-V) hex keys
11 functions, includes:

2 mm hex	2.5 mm hex	3 mm hex
4 mm hex	5 mm hex	6 mm hex
8 mm hex	T25 torx	Chain tool
Philips head screwdriver		
Flat head screwdriver		



STINGER 10
FOLDING TOOL

Compact, small minitool, hardened chromevanadium steel (CR-V) hex keys
10 functions, includes:

2 mm hex	2.5 mm hex	3 mm hex
4 mm hex	5 mm hex	6 mm hex
8 mm hex	T25 torx	Philips head screwdriver
Flat head screwdriver		

COLORS _ grey, lime



STINGER 8
FOLDING TOOL

Compact, small minitool, hardened chromevanadium steel (CR-V) hex keys
8 functions, includes:

2 mm hex	3 mm hex	4 mm hex
5 mm hex	6 mm hex	8 mm hex
Philips head screwdriver		Flat head screwdriver



TOOLBOX XL
TOOL BOX 0,6L

Original KLS design. Wide bottleneck (63 mm) for easy access. Waterproof lid with steep thread for fast access. Standard 74 mm outer diameter, fits to regular bottle cages. Removable padding inside to avoid rattling. Suitable for tools, road tubes and other small necessities.

WEIGHT _ 82 g
COLORS _ black



TRYKER NEW TOOL SET

Tool set made of sturdy plastic in Y-shape with rough surface treatment for optimal grip. Double-sided magnetically attached bits, made from highly durable steel for extended lifespan.

2 mm hex	2.5 mm hex	3 mm hex
4 mm hex	5 mm hex	6 mm hex
8 mm hex	T20 Torx	T25 Torx
T30 Torx	Cross PH2 screwdriver	Flat SL4 screwdriver
Flat SL6 screwdriver		



TRIDENT ALLENKEYS

Plastic handle
Hardened chromevanadium steel (Cr-V) keys

4 mm hex	5 mm hex	6 mm hex
----------	----------	----------



SPIKE CHAIN TOOL

2 density ergonomic handle
Chain hook, replaceable pin
For IG / HG / UG chains



SPARTAN 15MM PEDAL WRENCH

Ergonomic handle
Manipulation angle for better handling
Hardened chromevanadium steel (Cr-V)
15 mm box wrench



JACK 10 TIRE LEVERS

3 piece set of plastic levers
Large handle provides high leverage, spoke hook



E
C
C
O
D
E
X
E
H

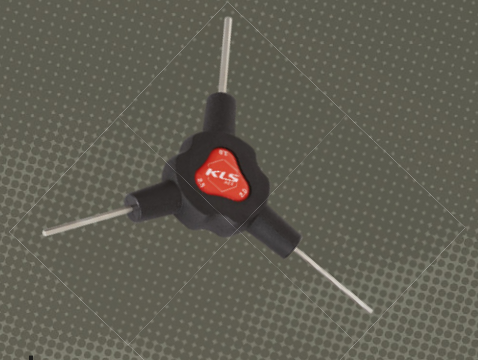

YPSI HEX SMALL
ALLENKEYS

YPSI HEX small is tool with 3 Allen keys in sizes 2 / 2,5 / 3 mm. High-quality CR-V steel. Sand blasted finished for firm grip.

2 mm hex	2.5 mm hex	3 mm hex
----------	------------	----------

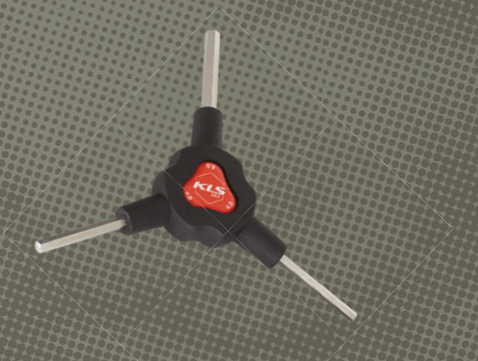

YPSI HEX BIG
ALLENKEYS

YPSI HEX big is tool with 3 allen keys in sizes 4 / 5 / 6 mm. High-quality CR-V steel. Sand blasted finished for firm grip.

4 mm hex	5 mm hex	6 mm hex
----------	----------	----------

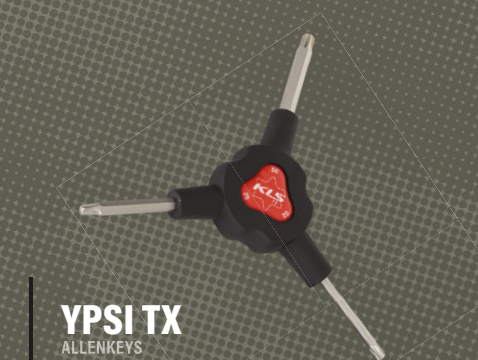

YPSI TX
ALLENKEYS

Smart tool with 3 torx keys in sizes T20 / T25 / T30. High-quality CR-V steel. Sand blasted finished for a firm grip.

T20 torx	T25 torx	T30 torx
----------	----------	----------

HEXCODE
ALLENKEYS

Hardened chrome vanadium steel (Cr-V) keys with ball ends for up to a 30° angle of rotation
10-hex keys, includes:

1.5 mm hex	2 mm hex	2.5 mm hex
3 mm hex	4 mm hex	5 mm hex
6 mm hex	8 mm hex	10 mm hex





CARBON ASSEMBLY COMPOUND 12

1 MULTIFUNCTIONAL OIL

BIKE CLEANER 5

4 PREMIUM LUBE

SOFT BRUSH 9

2 SILICONE OIL

DETAILING BRUSH 7

11 BIKE POLISH

BRUSH / CLAW 8

3 CHAIN OIL

MULTI-GREASE 6

CHAIN CLEANER 10

CLEANERS & LUBRICANTS

LUBRICATION

The ORANGE line includes various lubricants, such as chain oil, universal oil or premium grease. Products from the orange line allow you to take care of every lubrication point of your bike: from chain, through cables to every bearing and axle. High-quality ingredients and modern additives reduce friction and protect the sensitive parts of a bicycle against excessive wear and corrosion.



CLEANING

To keep the bicycle clean and shine, and ensure smooth operation of its components, you should reach for the products from the BLUE line. Gentle but very effective cleansing ingredients thoroughly remove impurities, leaving the surface free of dirt, dust and old grease, and prepare the bicycle to put on fresh lubricants.



CARE

Products from the GREY line give finishing touch after cleaning the bike to protect any painted and non-painted surfaces leaving deep shine and prevent dirt and wet from sticking.





CRYSTAL CHAIN CLEANER

Plastic body
With practical handle for easy use
Removable bristles for easier maintenance
Chain is cleaned simultaneously from 4 different sides
Rubber pad prevents leaking where chain exits the cleaner
Capacity 20 ml for cleaning fluid
Use of aggressive cleaners is not recommended (KLS BIKE CLEANER is suitable)



SILICONE OIL

Silicone Oil is suitable for oiling and preservation during repairing and maintaining bicycles, particularly shock absorbing forks (do not confuse with oils for filling shock absorbers), O-rings, rubber seals, cables, Bowden cables, and pins in gears or lever-key switches. It may also be used for general oiling.
Spray 200 ml



CHAIN OIL

As the name suggests, Chain oil is white lubricant for chains. The lubricant flows easily into the open spaces in the chain, lubricates the chain and protects it against rust. It is also suitable for O-ring chains. It doesn't contain excessive adhesive components and is, therefore, better suited for the lubrication of chains on mountain as well as highway bicycles under all types of conditions, from dust to rain.
Spray 200 ml / Applicator 50 ml



PREMIUM LUBE WHITE

Bike lube „white“ is a highly effective white grease with content of PTFE (polytetrafluoroethylene) useful for the lubrication of slide and roll bearings, hubs, heads, pedals, etc. The lubricant excels in its high resistance against water and provides a long life for all bearings.
Tube 100 g



MULTIFUNCTIONAL OIL BIO

Multifunctional Oil BIO is a biodegradable all-purpose fluid suitable for general lubrication, loosening of rusted joints, and prevention of corrosion.
Spray 200 ml / Applicator 100 ml



MULTI DEGREASER

„Multi“ degreaser is cleaner / degreaser in one. By simply spraying on the agent it quickly removes grease, oil, dirt and brake fluid. It is suitable for degreasing chains before being lubricated by Chain oil and also degreasing bearings, brake and clutch pads, and other metal components.
Spray 750 ml

CLEANING SET

Bucket with everything you need to keep your bike working and looking good all season. Contains: Bucket, 3x brush, sponge, wipe cloth, Chain oil 50 ml, Bike cleaner 500 ml, Bike polish spray 200 ml.



BIKE CLEANER

Bike Cleaner is a maintenance and cleaning agent for cleaning bicycles from mud and other contamination. Higher foaming ability ensures a lower consumption of the agent. Bike Cleaner is applied by spraying on the contaminated spots (derailleurs, pedals, hubs, frame). It is particularly suitable to clean very contaminated parts (chains, sprockets, etc.) where it adheres due to its foaming ability and thus the product consumption is lower. It does not harm paint.

Applicator 500 ml / 1000 ml



CARBON ASSEMBLY COMPOUND

Special assembly compound suitable for carbon fibre components like seatposts, stems, handlebars, carbon saddle rails etc. Suitable for carbon-carbon, carbon-aluminium and even aluminium-aluminium connections.

Volume: 30 g

Application temperature difference: -15 °C to 70 °C.



HANDCLEANER

Handcleaner is a highly effective cleansing cream that does not contain any solvents or chemicals. Thanks to the abrasive particles it can remove even the biggest dirt from hands, but it is also skin friendly. Handcleaner contains lanolin, which prevents hand skin cracking after washing.

Dose 500 g



BIKE POLISH

Bike polish is cleaner / degreaser. By simply spraying on the agent it quickly removes grease, oil, dirt and brake fluid. It is suitable for degreasing chains before being lubricated by Chain oil and also degreasing bearings, brake and clutch pads and other metal components.

Spray 200 ml



E-BIKE CLEANER ^{NEW}

Highly effective cleaning agent for cleaning and maintenance of bicycles, specifically adapted for electric bikes. It removes dirt, mud, and grease from all bicycle surfaces with consideration for the wiring and electronic devices of the electric bike drive units. Its even higher foaming capacity significantly prolongs its effectiveness and reduces its consumption.

E-Bike Cleaner is biodegradable, does not damage bicycle paint, carbon parts, or brake pads.

Usage: cleaning agent for bicycles and electric bikes.





KLS CONTROLSTOP V-01 CARTRIDGE

PSC - power / safe / control technology - shorter braking distance
 All-weather compound
 - dry conditions (red compound)
 - wet conditions (grey compound)
 Antisqueal design
 Excellent rim cleaning profile
LENGTH_ 72 mm



KLS CONTROLSTOP VR-01

Replacement brake shoes for KLS CONTROLSTOP V-01



KLS CONTROLSTOP V-02

PSC - power / safe / control technology - shorter braking distance
 All-weather compound
 - dry conditions (red compound)
 - wet conditions (grey compound)
 Antisqueal design
 Excellent rim cleaning profile
LENGTH_ 72 mm



KLS DUALSTOP V-01 CARTRIDGE

All-weather compound
 - dry conditions (red compound)
 - wet conditions (black compound)
 Antisqueal design
 Excellent rim cleaning profile
LENGTH_ 72 mm



KLS DUALSTOP VR-01

Replacement brake shoes for KLS DUALSTOP V-01



KLS DUALSTOP V-02

All-weather compound
 - dry conditions (red compound)
 - wet conditions (black compound)
 Antisqueal design
 Excellent rim cleaning profile
LENGTH_ 72 mm



KLS POWERSTOP V-01 CARTRIDGE

All conditions medium compound
Antisqueal design
LENGTH_ 72 mm



KLS POWERSTOP VR-01

Replacement brake shoes for KLS POWERSTOP V-01



KLS POWERSTOP V-02

All conditions medium compound
Antisqueal design
LENGTH_ 72 mm



KLS POWERSTOP C-02 CANTILEVER

All conditions medium compound
Antisqueal design
LENGTH_ 72 mm



BRAKE PADS KLS D-14 / D-16 / D-18 RADIATOR, ORGANIC

BRAKE PAD WITH COOLING FIN

Replaceable disc brake pad with detachable cooling fin. Ideal for riders who enjoy longer descents. Cooling fins dissipate heat more effectively and reduce fading of brakes. Brake pads can be replaced by KLS D-14 / D-16 / D-18 RADIATOR CARTRIDGE, ORGANIC. Cooling fins can be reused.

D-14 COMPATIBILITY WITH SHIMANO BRAKES:

BR-M9000, BR-M9020, BR-M987, BR-M985, BR-M8100, BR-M8000, BR-M785, BR-M7100, BR-M7000, BR-M675, BR-M666, BR-M6100, BR-M6000, BR-M615, BR-S7000, BR-S700, BR-CX77, BR-RS785, BR-R785, BR-R517, BR-R317

D-16 COMPATIBILITY WITH SHIMANO BRAKES:

BR-M8120, BR-M8020, BR-M7120, BR-M6120, BR-M820, BR-M810, BR-M640, BR-MT520, BR-MT420

D-18 COMPATIBILITY WITH SHIMANO BRAKES:

BR-M9100, BR-M9110, BR-M8110, BR-R9170-F, BR-R9170-R, BR-R8070-F, BR-R8070-R, BR-R7070-F, BR-R7070-R, BR-4770-F, BR-4770-R, BR-RS805-F, BR-RS805-R, BR-RS505-F, BR-RS505-R, BR-RS405-F, BR-RS405-R, BR-RS305-F, BR-RS305-R, BR-U5000-F, BR-U5000-R, BR-RX810-F, BR-RX810-R, BR-RX400-F, BR-RX400-R

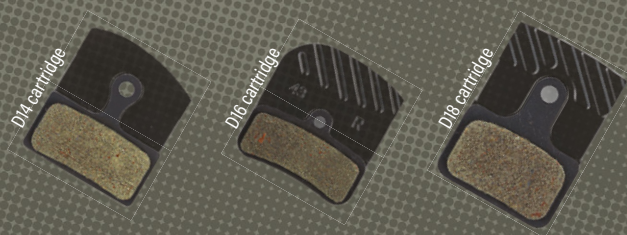

SPARE DISC BRAKE PADS KLS D-14 / D-16 / D-18 RADIATOR, ORGANIC (PAIR)

SPARE DISC BRAKE PAD FOR KLS D-14 / D-16 / D-18 RADIATOR, ORGANIC

Brake pad with thinner back plate which is strengthened with steel, allows to use cooling fins (not part of the packaging). Made from organic compound with added kevlar for stable breaking power. Spare brake pads should be used only as replacement for used BRAKE PADS KLS D-14 / D-16 / D-18 RADIATOR, ORGANIC with cooling fins!



SHIMANO	KLS D-04 KLS D-04 OEM (25 PAIRS) KLS D-04S		SHIMANO BR-M575, M495, M486, M485, M475, M465, M447, M446, M445, M416, M416A, M415, M395, M375, M365, M355, M315, NEXAVE BR-C601, C501, ALIVIO BR-M4050, ACERA BR-M3050, TOURNEY BR-TX805, DEORE BR-M525, M515, M515LA, LX BR-T675, BR-T615, PROMAX DSK-909, SOLVE, LUCID, E-CAPSULE, F1, GIANT ROOT, TEKTRO ORION 4P×2P, SL, ORION, GIMINI SL, AURIGA, E-COMP, SUB, E-SUB, TUNE, E-TUNE, TWIN, E-TWIN, VOLANS, VELA, DORADO, DRACO, AQUILA, ARIES, MIRA, HDC, PARABOX R, HYLEX, SPYRE, SLC, HY, RD, SLATE X2, DASH SPORT, RST D-POWER, QDH-01, CLARKS S2
	KLS D-03 KLS D-03S		SHIMANO BR-T605, M545, R505, ALFINE BR-S501, S500, XTR BR-M975, M966, M965, SAINT BR-M800, HONE BR-M601, DEORE XT BR-M776, M775, M765, LX BR-T665, M585, BR-M596, M595, M535, SLX BR-M665
	KLS D-14 KLS D-14S		SHIMANO BR-M9000, BR-M9020, BR-M987, BR-M985, BR-M8100, BR-M8000, BR-M785, BR-M7100, BR-M7000, BR-M675, BR-M666, BRM6100, BR-M6000, BR-M615, BR-S7000, BR-S700, BR-CX77, BR-RS785, BR-R785, BR-R517, BR-R317
	KLS D-16 KLS D-16S		BR-M8120, BR-M8020, BR-M7120, BR-M6120, BR-M820, BR-M810, BR-M640, BR-MT520, BR-MT420, TRP QUADRIEM
AVID	KLS D-01 KLS D-01S		AVID ELIXIR, SRAM XX, SRAM XO SERIES
	KLS D-02 KLS D-02S		AVID JUICY BB7, JUICY ULTIMATE, PROMAX DSK-950
	KLS D-15		AVID BB5
HAYES	KLS D-17 KLS D-17S		AVID XO TRAIL
	KLS D-05 KLS D-05S		HAYES STROKER TRIAL
	KLS D-06 KLS D-06S		HAYES STROKER RYDE, DYNO
	KLS D-07 KLS D-07S		HAYES PRIME
FORMULA	KLS D-08 KLS D-08S		HAYES SOLE HYDRAULIC, MX2, MX3, MX4, GX AND SOLE MECHANICAL
	KLS D-09 KLS D-09S		FORMULA ORO
	KLS D-10 KLS D-10S		FORMULA MEGA ONE, R, R1, RX, RC, RO
MAGURA	KLS D-12 KLS D-12S		MAGURA JULIE CALIPER 2001-2008
	KLS D-11 KLS D-11S		MAGURA CLARA 2001-2002 / LOUISE 2002-2006 / LOUISE FR
ZOOM	KLS D-13		ZOOM
SRAM	KLS D-19 KLS D-19S		SRAM CODE 2011+, GUIDE RE, CODE R, CODE RSC 2018
	KLS D-20 KLS D-20S		SRAM RED 22 B1, FORCE 22, FORCE 1, CX1, RIVAL 22, RIVAL 1, 700 B1 HRD, HRR



SINTERED METALLIC PAD HIGH FRICTION COMPOUND

- Durable for heavy duty use
- High working temperature
- Consistent braking power and very limited fading during long descends with intensive braking
- Excellent performance in wet and muddy condition



ORGANIC RESIN PAD SOFT COMPOUND REINFORCED BY KEVLAR

- Quiet
- Low working temperature
- Higher modulation at the lever
- Perfect for daily use in all-weather condition

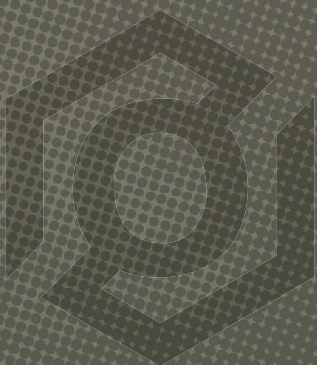

S
A
P
E
K
A
B





WHEELS

WHEEL	RIM	HUB	SPOKES	COLOR	SIZES	TUBELESS
VALOR 3 F	KLS VALOR 3, double wall, single eyelet, 32h	15x110mm Thru Axle, Center-Lock	32 steel spokes	Black	28/29"; 27,5"	•
VALOR 3 R	KLS VALOR 3, double wall, single eyelet, 32h	12x148mm Thru Axle, Center-Lock, MicroSpline	32 steel spokes	Black	28/29"; 27,5"	•
VALOR 21 F	KLS VALOR 21, double wall, single eyelet, 32h	15x110mm Thru Axle, Center-Lock	32 steel spokes	Black	28/29"	•
VALOR 21 R	KLS VALOR 21, double wall, single eyelet, 32h	12x148mm Thru Axle, Center-Lock, 8/9/10/11 speed	32 steel spokes	Black	28/29"	•
DRAFT DYNAMO DSC	KLS DRAFT, double wall, single eyelet, 32h	Nut type, Center-Lock disc brakes	32 steel spokes	Black	28/29"	
DRAFT DYNAMO V-BRAKE	KLS DRAFT, double wall, single eyelet, 32h	Nut type, V-brake	32 steel spokes	Black	28/29"; 26"	
DRAFT DSC F	KLS DRAFT, double wall, single eyelet, 32h	Disc, 6-bolt, with QR	32 steel spokes	Black	28/29"; 27,5"; 26"	
DRAFT DSC R	KLS DRAFT, double wall, single eyelet, 32h	Disc, 6-bolt, with QR 8/9/10/11 speed	32 steel spokes	Black	28/29"; 27,5"; 26"	
DRAFT F	KLS DRAFT, double wall, single eyelet, 32h	V-brake with 9x100mm QR	32 steel spokes	Black, Silver	28/29"; 27,5"; 26"	
DRAFT R	KLS DRAFT, double wall, single eyelet, 32h	V-brake with 10x135mm QR	32 steel spokes	Black, Silver	28/29"; 27,5"; 26"	
EVENT F	KLS EVENT, single wall, 36h	Nut type, 9x100mm axle included	36 steel spokes	Silver	28/29"; 26"	
EVENT R	KLS EVENT, single wall, 36h	Nut type, 10x135mm axle included, 7 speed	36 steel spokes	Silver	28/29"; 26"	
WASPER F	KLS WASPER single wall, 32h	V-brake with 9x100mm QR	32 steel spokes	Black	24"	
WASPER R CASSETTE	KLS WASPER single wall, 32h	V-brake with 10x135mm QR, 6/7 speed	32 steel spokes	Black	24"	
WASPER R FREEWHEEL	KLS WASPER single wall, 32h	V-brake with 10x135mm QR, 6/7 speed	32 steel spokes	Black	24"	

RIMS

RIM NAME	WEIGHT	SIZE	OUTER / INNER WIDTH	ERD	HOLES	FINISH	TUBELESS	EYELETS	COLOR
VALOR 3	560 g (29") 528 g (27.5")	622 x 30 584 x 30	34 / 30 mm	598,3 mm (29") 559,9 mm (27.5")	32	black anodised	•	single	black
VALOR 2	502 g (29") 474 g (27.5")	622 x 27 584 x 27	31 / 27 mm	595,7 mm (29") 557,3 mm (27.5")	32	black anodised	•	single	black
VALOR 21	511 g (29")	622 x 21	27 / 21 mm	597,4 mm	32	black anodised	•	single	black
BRAVE	590 g	559 x 23	30 / 23 mm	529,6mm	32 / 36	black anodised		single	black
FLINT	654 g	622 x 22	26 / 22 mm	574,8 mm	32	black anodised	•		black
SPARK DSC	548 g	622 x 15	21 / 15 mm	589,8 mm	32 / 28	black anodised		single	black
SPARK V-BRAKE	548 g	622 x 15	21 / 15 mm	589,8 mm	32	black anodised		single	black
DRAFT DSC	536 g (29") 512 g (27.5") 490 g (26")	622 x 21 584 x 21 599 x 21	26 / 21 mm	597,6 mm (29") 559,2 mm (27.5") 534,1 mm (26")	32	black / silver anodised		single	black / silver
DRAFT V-BRAKE	536 g (29") 512 g (27.5") 490 g (26")	622 x 21 584 x 21 599 x 21 507 x 21	26 / 21 mm	597,6 mm (29") 559,2 mm (27.5") 534,1 mm (26")	32 / 36	black / silver anodised		single	black / silver
WASPER	440 g (24") 360 g (20") 351 g (16")	507 x 19 406 x 19 349 x 19	25 / 19 mm	492,3 mm (24") 390,6 mm (20") 294,3 mm (16")	36 (24") 28 (20") 20 (16")	silver anodised			silver

RIM TAPES

RIM TAPE (AV/FV)	OEM
28"/29" x 22 mm	•
28"/29" x 16 mm	•
27,5" x 22 mm	•
26" x 22 mm	•
26" x 16 mm	•
24" x 14 mm	
20" x 14 mm	



TUBELESS RIMTAPE

TUBELESS RIMTAPE is flexible, made with fabric support and now with much stronger natural rubber adhesive for easier application and better sealing.

Tape is 9 meter long and should be enough for two 29" wheels

COLOUR_ Black

SIZE_ 23mm, 25mm, 27mm, 29mm, 31mm, 35mm



KMC CHAINS

KMC Chain old name	KMC Chain new name	SPEED	MTB	ROAD	FITNESS/ SINGLE SPEED	BMX, FREESTYLE, FIXIE	E-BIKES	SHIMANO COMPATIBLE	SRAM COMPATIBLE
KMCX11	KMC X11	11	•	•				HG600/601	PC1110/PC1130
KMCX11EL	KMC X11EL	11	•	•				HG900/901/HG700/701	PC1170/ RED22
KMC X10EL	KMC X10EL	10	•	•				4601/HG54/HG95	PC1071/PC1051/PC1031
KMC X9	KMC X9	9	•	•				HG93/HG73/HG53	PC991/PC971/PC951
KMC Z7	KMC Z8.3	8	•	•				HG71/HG40	PC890/870/850/830
KMC Z51	KMC Z7	7	•	•				HG71/HG40	PC10
KMC Z33	KMC Z6	6	•	•				HG71/HG40	PC100
KMC Z510	KMC Z1 Wide	1			•			ALFINE/ NEXUS	AUTOMATIX
KMC Z410	KMC S1	1				•		CN-NX10	PC1/PC7X
KMC e1	KMC e1	1					•		
KMC e9T NPNP	KMC e9T NPNP	9					•		
KMC e10T NPNP	KMC e10T NPNP	10					•		
KMC e11T NPNP	KMC e11T NPNP	11					•		
KMC X12 NPNP	KMC X12 NPNP	12	•	•					XX1 Eagle, X01 Eagle, GX Eagle, NX Eagle

KMC eBike chains are compatible with BOSCH drivetrains as well as most of the other eBike drivetrains like SHIMANO, PANASONIC, etc.

KELLYS BICYCLES IS OFFICIAL KMC DISTRIBUTOR

Foundation of KMC began in 1977 in Taiwan. Since then, KMC has been concentrating on chain design and production for nearly 40 years. KMC sales reach all over the world. KMC is the world leader in chain manufacturing. Based on its bicycle chain manufacturing technologies, KMC also produces a variety of other chain products, like automobile timing chains, motorcycle chains, and industrial chains. KMC invests a lot in their R&D. KMC has broken their past achievement records: the first chain manufacturer to release a Super Lightweight chain, to offer Color chain (including Titanium-Nitride coated chain and Patriot chain), to use Diamond-Like Coating (DLC) reduced-friction technology on the chain, and to achieve the chain industry's first Carbon Footprint assessment certificate to show its commitment to eco-friendly manufacturing.





CABLES

NAME	STAINLESS STEEL	GALVANIZED	BLACK	100 pcs
GEAR WIRE 210 cm *	•	•		
BRAKE WIRE MTB+ROAD 200 cm *	•	•		
GEAR WIRE 210 cm / 100 pcs	•	•		
MTB BRAKE WIRE 200 cm / 100 pcs	•	•		
GEAR OUTER CASING 1pc *			•	
BRAKE OUTER CASING 1pc *			•	
GEAR OUTER CASING / 25m			•	
BRAKE OUTER CASING / 25m			•	
END CAPS FOR GEAR WIRE				•
END CAPS FOR BRAKE WIRE				•
END CAPS FOR GERAR CASING				•
END CAPS FOR BRAKE CASING				•

* END PLUGS INCLUDED

TUBE REPAIR KITS



TUBE REPAIR KIT	DESCRIPTION
TUBE REPAIR KIT	show box consist of 50 plastic boxes plastic box consist of: 5 ml of glue, 2 pcs of 20 mm round patches, 2 pcs of 25 mm round patches, 2 pcs of 24 x 35 mm rectangle patches, 1 pc of sand paper, instruction manual
MTB TUBE REPAIR KIT WITH SELF ADHESIVE SQUARE PATCHES	6 pcs of Premium quality self-adhesive MTB patches in plastic box Sandpaper for tube preparation included Patch dimensions 25 x 25 mm instruction manual

KLS INNER TUBES

WHEEL SIZE	INCHES	ETRTO	AV40 45°	AV40	AV40 FT	AV48	FV39	FV48	DV40	AV40 OEM	FV39 OEM	DV40 OEM	FV48 OEM
700	700 x 19-23C	18/23-622		•					•				
	700 x 25-32C	25/32-622/630				•		•	•				
	700 x 35-43C	35/44-622/630				•		•	•	•			•
	700 x 47C	47-622			•			•					
28" / 29"	29 x 2,20-2,50	58/62-622						•					
	29 x 1,75-2,125	47/57-622					•			•	•		
27,5"	27,5 x 2,5-3,0	64/76-584					•						
	27,5 x 2,1-2,4	56/60-584						•					
	27,5 x 1,75-2,125	47/57-584		•	•		•						
26"	26 x 2,10-2,40	54/60-559		•				•					
	26 x 1,75-2,125	47/57-559		•	•	•		•	•	•	•		
	26 x 1-3/8	37-590							•				
	26 x 1,25	32-559		•									
24"	24 x 1,75-2,125	47/57 - 507		•					•	•			
	24 x 1-3/8	37-540							•			•	
20"	20 x 1,75-2,125	47/57 - 406		•					•	•			
16"	16 x 1,75-2,0	47/57 - 305		•									
12 1/2"	12-1/2 x 2-1/4	57-203	•										

* OEM packaging includes 50 pcs of tubes



TYRES

NAME	ETRTO	INCHES	TPI	DEDICATED FOR					COLOR		PROTECTION TECHNOLOGY		
				MTB	CROSS/ TREKKING	ROAD	GRAVEL	CITY	BLACK	BLACK/ REFLEX	CAP GUARD*	LIGHT GUARD**	KEVLAR INSIDE***
HORIZON	23 - 622	700 x 23C	33			•			•		•		
WASP	47 - 622	700 x 45C	22	•					•				•
RADIUS	47 - 622	700 x 45C	22		•				•		•		
ELEVATION	47 - 622	700 x 40C	22					•	•			•	
ATTACK	54 - 584	27,5 x 2,1	33	•					•				•
	57 - 584	27,5 x 2.25	33					•					•
	54 - 622	29 x 2,1	33	•					•				•
METROPOLIS	47 - 559	26 x 1,75	22					•	•		•		
SUBURBAN	54 - 559	26 x 2,0	22	•					•			•	
CENTER	47 - 559	26 x 1,75	22					•	•		•		
SLICER	40 - 622	700 x 38C	33				•						
RAVEL	40 - 622	700 x 38C	33				•						
GRAVA	42 - 622	700 x 40C	33				•						
RADIUS	40 - 622	700 x 38C	22		•				•				
	47 - 622	700 x 45C	22		•				•				
ELEVATION	47 - 305	16 x 1,75	22					•	•				
	54 - 406	20 x 1,95	22					•	•				
	47 - 507	24 x 1,75	22					•	•				
	47 - 559	26 x 1,75	22					•	•				
	47 - 559	26 x 1,75	22					•		•			
	50 - 584	27,5 x 2.0	22					•	•				
	40 - 622	700 x 38c	22					•	•				
	40 - 622	700 x 38c	22					•		•			
ATTACK	54 - 559	26 x 2.10	30	•					•				
	54 - 584	27,5 x 2.10	22	•					•				
	54 - 584	27,5 x 2.10	30	•					•				
	54 - 622	29 x 2.10	22	•					•				
	54 - 622	29 x 2.10	30	•					•				
ATTACKER	57 - 622	29 x 2.25	33	•					•				
SUBURBAN	54 - 559	26 x 2.0	22	•					•				
SNAKE	56 - 559	26 x 2.1	22	•					•				
CROSSTOWN	37 - 540	24 x 1 3/8	22					•	•				
	37 - 590	26 x 1 3/8	22					•	•				
HORNET	54 - 406	20 x 2.0	22					•	•				
	54 - 507	24 x 2.0	22					•	•				
PARALAX	47 - 406	20 x 2.0	22					•	•				
COUGAR	47 - 305	16 x 1.75	22					•	•				
STRIKER	57 - 203	12 1/2 x 2 1/4	22					•	•				

*CAP GUARD PROTECTION- is special nylon fabric in the area of the tread, which increases the resistance of the tire against punctures while maintaining a low weight

**LIGHT GUARD PROTECTION- is a protective layer made of a special adhesive mixture called „PTR“ with a thickness of 1.2 mm, which provides extra protection against tire puncture

***KEVLAR INSIDE PROTECTION- is kevlar belt reinforcement of thread area for maximum protection while maintaining a low weight



NOTUBY II NEW

TUBELESS TIRE REPAIR KIT

NOTUBY II is a practical repair kit for punctures. It includes threading needle with wicks, CO2 adapter and threaded bracket for CO2 cartridge. The wicks are securely stored in a waterproof case along with a threading needle. It can be attached to your bicycle by two screws below bottle cage. Includes: 3pcs wicks 3.5*50 mm and 3pcs wicks 1.5*50 mm



NOTUBY

TUBELESS TIRE REPAIR KIT

NOTUBY is a compact repair kit for punctures, that can save your ride. It can be used to seal holes that the sealant alone cannot seal. The wicks are securely stored in a waterproof case along with a threading needle. 5 pcs of wicks included



SEALREFILL

SEALANT SYRINGE

SEALREFILL is a syringe suitable for filling tubeless systems with sealant. It will also serve well to check the sealant level in the tires. The enclosed tubes are narrow enough to be pushed through the valve. Includes a silicone hose, a valve and two hard tubes.



SEALJECTOR

SEALANT SYRINGE

SEALJECTOR is syringe suitable for application of tubeless sealant into tires. Includes soft silicon hose.



INSERT BRO

TUBELESS VALVE SET

Tubeless valves INSERT BRO are made of light aluminium alloy. Comes in set of two with rubber sealing, alloy O-ring and caps with in-built tool for valve core removal for easy sealant. It can also serve as spoke wrenches (3.30 and 3.40 mm). Valves are compatible with most of the common rims and tire inserts.

COLORS black, blue, gold, green, orange, purple, red
SIZE 44 mm



TUBELESS VALVES SET

Made of aluminium alloy
Packaging include rubber sealing and aluminium O-ring
Removable valve core for easier sealant filling
Valve cap with hole designed to remove valve core for easier sealant filling
SIZE 40 mm, 60 mm

MILKYSEAL

TUBELESS SEALANT

Tubeless sealant KLS MILKYSEAL is designed to prevent punctures in the tread area on tubeless tires that are up to 6 mm. Recommended amount for one wheel: 60 - 120 ml for XC tires and 120 - 180 ml for AM, FR and DH tires. Sealant lasts for 3 - 12 months (depends on weather conditions and frequency of use). The sealant is compatible with CO2 and does not freeze, so it is suitable for all-season use. Contains latex.
SIZE 1L



MILKYSEAL PRO NEW

TUBELESS SEALANT

The sealant Milkyseal PRO is perfect for race riders who require immediate sealing of even relatively big punctures. With its innovative formula with Micro Fibre particles, it effectively seals tires and all holes up to 6+mm. Punctures are sealed quicker keeping pressure in tires. It's suitable for road tires with pressures up to 8.5 Bar and downhill riding with pressures below 1 Bar. The sealant remains effective for 6-9 months, meaning less frequent reapplication. Moreover, it's environmentally friendly as it does not contain any latex or amonia.
SIZE 1L



TUBELESS TYRE REPAIR KIT

Repair kit suitable for all tubeless tyres
Fixes bigger holes, that sealant cannot fix
Set for repairing tubeless tires consists of:
5 stripes of 10 cm long repair knots with diameter 3.5 mm
5 stripes of 5 cm long repair knots with diameter 1.5 mm
screw drill & plug tool
small knife ideal for cutting off excessive knot material
5 ml of rubber solution
instruction manual



SIZE CHARTS

CASUAL/BIKE WEAR

HEIGHT:

Measure from the top of the head to the floor while standing upright.

CHEST:

Measure around your chest, with arms relaxed down at sides. Measure around the fullest part of your chest, make sure the measuring tape will go around your shoulder blades. Keep the tape parallel to the floor.

WAIST:

Measure around natural waistline, keeping the tape a bit loose.

HIPS:

Measure with your feet together, keep tape straight and measure around the widest part of your hips.

INSEAM:

Measure inside of leg from the crotch to the ankle bone.

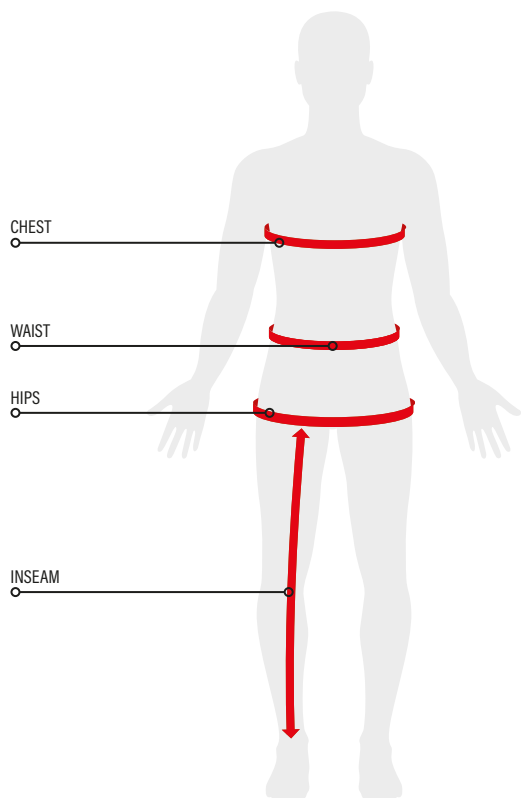

BIKE WEAR

MEN'S SIZES (CM):	S	M	L	XL	XXL
HEIGHT:	165 - 170	170 - 175	175 - 180	180 - 185	185 - 190
CHEST:	88 - 92	92 - 96	96 - 100	100 - 106	106 - 112
WAIST:	75 - 80	80 - 84	84 - 88	88 - 94	94 - 100
INSEAM:	81	82	83	84	85

WOMEN'S SIZES (CM):	S	M	L	XL	XXL
HEIGHT:	160 - 164	164 - 168	168 - 172	172 - 176	176 - 180
CHEST:	85 - 90	90 - 94	94 - 100	100 - 106	106 - 112
WAIST:	68 - 72	72 - 76	76 - 80	80 - 86	86 - 92
INSEAM:	75,5	77	78,5	78,5	80

CASUAL WEAR

MEN'S SIZES (CM):	S	M	L	XL	XXL
HEIGHT:	165 - 175	168 - 178	171 - 181	174 - 184	179 - 189
CHEST:	88	94	100	106	112
WAIST:	78	84	90	96	102
HIPS:	91	97	103	109	115

WOMEN'S SIZES (CM):	XS	S	M	L	XL
HEIGHT:	159 - 169	162 - 172	165 - 175	168 - 178	171 - 181
CHEST:	82	88	94	100	106
WAIST:	64	70	76	82	88
HIPS:	90	96	102	108	114



S
I
Z
E
C
H
A
R
T
S

RIDER / SIZE CHARTS

GLOVES

PALM CIRCUMFERENCE:

Measure around your hand with a tape measure across your palm. You should use your dominant hand, the right if you are right-handed, and the left if you are left-handed.

HAND LENGTH:

To determine hand length measure from the tip of your longest finger to the base of your palm at the wrist.

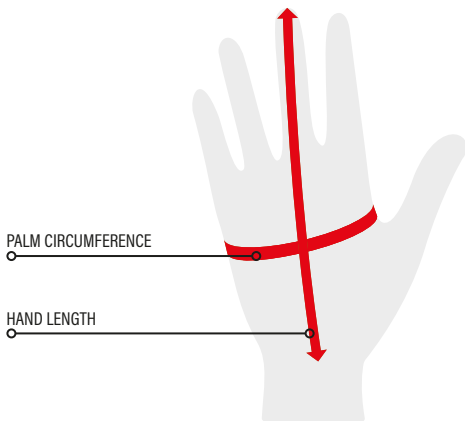

GLOVES SIZE (CM):	XS	S	M	L	XL	XXL
PALM CIRCUMFERENCE:	17,8	19,1	20,3	21,6	24	26,7
HAND LENGTH:	15,7	17	18,3	19,7	21,1	22,5

SERVICE & CARE

BICYCLE



CONTACTS

AUSTRIA

Bike Trade – Christian Willingshofer
H.Rantschl Gasse 31
8605 Kapfenberg
tel.: +43 676 4077278
e-mail: office@bike-trade.at

BULGARIA

VELOZONA LTD
25 OTEC PAISIY STREET
5100 GORNA ORHOVITSA
tel.: +359 887 800 104
e-mail: velozona@abv.bg

CYPRUS

TASOS ALETRAS Ltd.
266 TSERIOU AVENUE
2044 NICOSIA STROVOLOS
tel.: +35 722 321015
fax: +35 722 321731
e-mail: tasosaletras@cytanet.com.cy
www.aletrasbikes.com

CZECH REPUBLIC

KELLYS BICYCLES CZECH REPUBLIC s.r.o.
HAVLÍČKOVA 426
753 01 HRANICE
tel.: +420 581 698 810
e-mail: infoc@kellysbike.com

ESTONIA

VELOPLUS
SAKU 3
11314 TALLINN
tel.: +372 6 556 977
fax: +372 6 556 308
e-mail: veloplus@veloplus.ee
www.veloplus.ee

FINLAND

Kuopion pyöräkauppa bikemania oy
Puijonkatu 28
70100 KUOPIO
Tel.: +358 442 303 867
e-mail: posti@bikemania.fi

FRANCE

Eurotop (SAICO SA)
213 Route de Rouffach Les Erlens
68920, Wettolsheim
Tel.: +33 389 203 322
e-mail: eurotop@saico.fr
www.eurotop-sport.com

GEORGIA

LTD Freeriders
Shatberashvili street #2 Apartment #55
0179 Tbilisi
Tel.: +995 574 944 555
e-mail: infogeoriders@gmail.com

GERMANY

KELLYS BICYCLES DEUTSCHLAND
AM WALDBERG 15
12683 BERLIN
tel.: +49 (0)30 510 61 837
fax: +49 (0)30 510 61 838
e-mail: kellysdeutschland@kellysbike.com

HUNGARY

KELLYS BICYCLES s.r.o.
1051 Budapest,
Arany Janos u. 15.
tel.: +36 20 975 5732
e-mail: infohu@kellysbike.com

ITALY

MODOLO ITALIA SRLS
VIA VENZONE 17
21028 VAZZOLA TV
tel.: +39 327 566 3036
tel.: +39 349 889 0142
e-mail: serena@modolo.com
e-mail: pietro.caschera@gmail.com

LATVIA

SIA AQUA PRO
GAROZES 1
LV-1004 RIGA
tel.: +371 762 6025
fax: +371 789 2053
e-mail: jurism@fans.lv

LITHUANIA

MB Bartrade Baltic
Raudondvario pl. 232
LT-47157, Kaunas
Tel.: +370 607 253 31
e-mail: baronas.aistis@gmail.com

POLAND

KELLYS Sp. z o.o.
UL. SPORTOWA 6N/2
55-200 OŁAWA
e-mail: infopl@kellysbike.com

REUNION

SARL ATCHIA IMPORT
123 RUE MONTHYON
97400 SAINT DENIS
REUNION ISLAND
Tel.: +262 692 49 39 49
e-mail: atchiaimport.sarl@orange.fr

SLOVAKIA

KELLYS BICYCLES s.r.o.
SLNECNÁ CESTA 374
922 01 VELKÉ ORVIŠTE
tel.: +421 333 213 111
fax: +421 333 213 199
e-mail: infosk@kellysbike.com

SLOVENIA

PE BIKE CENTER
ERJAVCEVA ULICA 5
SI-2000 MARIBOR
tel.: +386 242 018 36
e-mail: info@bike-center.si
www.bike-center.si

SWEDEN

JAMTLANDS CYKELFABRIK
KYRGATAN 27
S-83131 ÖSTERSUND
tel./fax: +46 63 12 72 22
e-mail: info@jamtlandscykelfabrik.se

SWITZERLAND

Bikedéal AG
Hausmattweg 10
3019 Bern
Switzerland
+41 79 137 91 95
info@bikedéal.ch

TAIWAN

UNI-VICTOR INT'L CORP.
NO. 1, RENHUAGONG 10th RD.,
DALI DIST.,
TAICHUNG 41278
TAIWAN
tel.: +886 4 249 16 008
fax: +886 4 249 16 007
e-mail: infotw@kellysbike.com

U.A.E

Asia Technics Limited
SD-7, Blue Shed
Jebel Ali Free Zone,
61207 Dubai,
United Arab Emirates
Tel.: +97150 5505442
+ 9714 8833013
e-mail: arjun@asiatechnics.com

UKRAINE

VELOPORTAL LLC
49/2 Peremohy avenue, build. L.
03057 KIEV
tel./fax: +380 44 331 9050
e-mail: info@veloport.com.ua
www.kellys.com.ua
www.klsparts.com.ua

UNITED KINGDOM

BALFA UK LTD
1 Alvescot Road
OX18 3JL Carterton
United Kingdom
e-mail: carterton@mountainmania.co.uk
www.mountainmaniacycles.co.uk

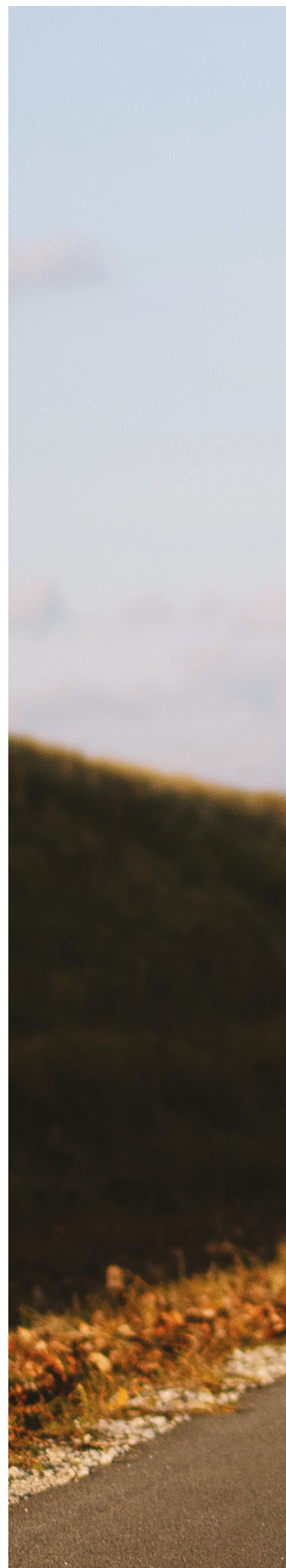



[INSTAGRAM.COM/KELLYSBIKES](https://www.instagram.com/kellysbikes)



[FACEBOOK.COM/KELLYSBICYCLES](https://www.facebook.com/kellysbicycles)



[YOUTUBE.COM/USER/KELLYSBICYCLES](https://www.youtube.com/user/kellysbicycles)



[KELLYSBIKE.COM](https://www.kellysbike.com)





©KELLYS BICYCLES. All rights reserved.
KELLYS and KELLYS BICYCLES are protected trademarks of Kellys group.

KELLYSBIKE.COM